

# CELVIANO

## USER'S GUIDE

# AP-300

# AP-S200

EN

### Initial Setup

---



Preparing a Power Supply



Turning the Power On/Off



Using the Pedals



Using Headphones

### Playing the Digital Piano

---



Selecting a Tone



Layering Two Tones (Layer)



Splitting Left and Right Keys (Split)



Using the Metronome

### Changing Sound Reverberation and Ambiance

---



Using Sound Mode Effects (Hall Simulator/Reverb and Surround)



Using Chorus



Adjusting the Sound Characteristics of the Acoustic Piano Presets (Acoustic Simulator)

### Changing the Pitch

---



Changing the Pitch in Semitone Steps (Transpose)

### Recording Performances in Real-Time

---



Recording a Performance with the MIDI Recorder



Recording a Performance with the Audio Recorder

### Connecting with a Smart Device

---



Using the Dedicated App

# Contents

<b>Overview of the Digital Piano</b>	<b>EN-6</b>
Part Names and Functions	EN-6
<b>Preparation Before Playing</b>	<b>EN-8</b>
Preparing a Power Supply	EN-8
Keyboard Cover	EN-9
Opening the Keyboard Cover	EN-9
Closing the Keyboard Cover	EN-10
Turning the Power On/Off	EN-11
Turning the Power On	EN-11
Turning the Power Off	EN-12
Adjusting the Volume	EN-12
Using the Supplied Wireless MIDI & Audio Adaptor	EN-13
Using Headphones	EN-14
Using the Music Stand	EN-15
The Top Panel of the Digital Piano (AP-300 only)	EN-16
Opening the Top Panel of the Digital Piano	EN-16
Closing the Top Panel of the Digital Piano	EN-17
<b>Read This First (Basic Operations and Settings)</b>	<b>EN-18</b>
Notation in this Manual	EN-18
Touch Button Operation	EN-19
Operation of the Touch Buttons Alone	EN-20
Touch Button and Keyboard Combination Operation	EN-20
Notification Tones	EN-23
Notification Tone Types	EN-23
<b>Listening to the Demo Songs</b>	<b>EN-24</b>
Playing the Demo Songs	EN-24
Operations Possible during Demo Song Playback	EN-24
Ending the Playback of Songs	EN-25
<b>Playing</b>	<b>EN-26</b>
Selecting a Tone	EN-26
Selecting a Single Tone	EN-27
Layering Two Tones (Layer)	EN-28
Splitting Left and Right Keys (Split)	EN-30
Splitting the Keyboard into Left and Right for Two-Person Performance (Duet)	EN-31
What is a Duet?	EN-31
Using the Duet Function	EN-32
Changing the Pitch Range	EN-33
Using the Pedals	EN-34
<b>Using the Metronome</b>	<b>EN-35</b>
Metronome On/Off	EN-35
Setting the Beat	EN-36
Setting a Tempo	EN-37
Adjusting the Volume	EN-38

<b>Applying Effects to Sound</b>	<b>EN-39</b>
Using Sound Mode Effects (Hall Simulator/Reverb and Surround) . . . . .	EN-39
Turning on/off Hall Simulator/Reverb and Surround . . . . .	EN-39
Selecting Hall Simulator/Reverb Presets . . . . .	EN-40
Adjusting Applied Hall Simulator/Reverb . . . . .	EN-41
Using Chorus . . . . .	EN-42
Adjusting Brilliance . . . . .	EN-43
Adjusting the Sound Characteristics of the Acoustic Piano Presets (Acoustic Simulator) . .	EN-44
Setting String Resonance . . . . .	EN-44
Setting Damper Resonance . . . . .	EN-45
Setting Damper Noise . . . . .	EN-46
Setting Key On Action Noise . . . . .	EN-47
Setting Key Off Action Noise . . . . .	EN-48
Setting Lid Simulator (AP-300 only) . . . . .	EN-49
<b>Adjusting Key Touch</b>	<b>EN-50</b>
Changing the Volume Made by the Strength of Pressure Placed on a Key (Touch Response) . . . . .	EN-50
Changing the Sensitivity of Touch Response . . . . .	EN-51
<b>Adjusting the Pitch of Sound</b>	<b>EN-52</b>
Changing the Pitch in Semitone Steps (Transpose) . . . . .	EN-52
Transpose . . . . .	EN-52
Fine-tuning (A-tuning) . . . . .	EN-53
Tuning . . . . .	EN-53
Shifting by Octaves (Octave Shift) . . . . .	EN-54
Shifting Upper1 Part by an Octave . . . . .	EN-54
Shifting Upper2 Part by an Octave . . . . .	EN-54
Changing the Scale Tuning (Temperament) of the Keyboard . . . . .	EN-55
Changing the Scale Tuning . . . . .	EN-55
Setting the Scale Tuning Base Note . . . . .	EN-56
Switching Stretch Tuning On/Off . . . . .	EN-56
<b>Listening to Songs</b>	<b>EN-57</b>
Types of Data that Can Be Played Back . . . . .	EN-57
Playing MIDI Data . . . . .	EN-57
Switching to MIDI Recorder . . . . .	EN-58
Selecting Songs for Playback from the Music Library . . . . .	EN-58
Selecting a MIDI Recorder Song for Playback . . . . .	EN-59
Selecting a USB Flash Drive Song for Playback . . . . .	EN-59
Changing the Tempo . . . . .	EN-61
Selecting a Playback Part . . . . .	EN-62
Playing Audio Data (WAV, MP3) . . . . .	EN-63
Data that Can be Played Back . . . . .	EN-63
Switching to Audio Recorder . . . . .	EN-63
Selecting a Song for Playback . . . . .	EN-64

<b>Recording a Performance</b>	<b>EN-65</b>
MIDI Recorder and Audio Recorder Features . . . . .	EN-65
Recording Features . . . . .	EN-65
Playback Features . . . . .	EN-67
Recording a Performance with the MIDI Recorder . . . . .	EN-68
Main Content Recorded by the MIDI Recorder . . . . .	EN-68
Preparing to Use the MIDI Recorder . . . . .	EN-68
Recording . . . . .	EN-69
Erasing the Recording of a Track . . . . .	EN-72
Recording a Performance with the Audio Recorder . . . . .	EN-73
Preparing to Use the Audio Recorder . . . . .	EN-73
Recording Audio Recorder Songs (WAV) Directly to a USB Flash Drive . . . . .	EN-74
Recording to the Audio Recorder while Playing Back Data Recorded to the MIDI Recorder . . . . .	EN-75
Deleting a Recorded File . . . . .	EN-77
<b>Using a USB Flash Drive</b>	<b>EN-78</b>
Using a Commercially Available USB Flash Drive – What You Can Do . . . . .	EN-78
Preparing a USB Flash Drive . . . . .	EN-79
Supported USB Flash Drives . . . . .	EN-79
Types of Data that Can be Handled by this Digital Piano . . . . .	EN-79
Inserting/Removing a USB Flash Drive from the Digital Piano . . . . .	EN-81
Formatting a USB Flash Drive . . . . .	EN-82
Operations with a USB Flash Drive . . . . .	EN-84
Saving MIDI Recorder Songs to a USB Flash Drive . . . . .	EN-84
Loading USB Flash Drive Files into the Digital Piano . . . . .	EN-85
Deleting USB Flash Drive Files . . . . .	EN-87
Copying MIDI Song Data to a USB Flash Drive Using a Computer . . . . .	EN-89
Copying Audio Data (WAV, MP3) to a USB Flash Drive Using a Computer . . . . .	EN-89
<b>Connecting Wirelessly</b>	<b>EN-90</b>
Connecting the Digital Piano to External Devices Wirelessly . . . . .	EN-90
Wireless (Bluetooth) Connectivity Settings . . . . .	EN-90
Wireless Function On/Off . . . . .	EN-90
Adjusting the Notification Tone Volume for Wireless Connection/Disconnection . . . . .	EN-91
Bluetooth Low Energy MIDI Connectivity . . . . .	EN-92
Bluetooth Audio Connectivity . . . . .	EN-93
Bluetooth Audio Pairing . . . . .	EN-93
Clearing Pairing Registration . . . . .	EN-95
Adjusting Wireless Audio Playback Volume . . . . .	EN-96
<b>Using the Dedicated App</b>	<b>EN-97</b>
Downloading the App (CASIO MUSIC SPACE) for Smart Devices . . . . .	EN-97

<b>Using with an External Device with a Cable Connection</b>	<b>EN-99</b>
Connecting to a Computer or Smart Device and Using MIDI . . . . .	EN-99
Computer Operating Environment . . . . .	EN-99
Connecting to a Computer . . . . .	EN-100
Smart Device Operating Environment . . . . .	EN-101
Connecting a Smart Device with USB MIDI . . . . .	EN-101
Outputting the Digital Piano's Sound to an Amplifier or Audio Equipment . . . . .	EN-102
Connecting to Audio Equipment . . . . .	EN-102
Connecting to a Musical Instrument Amplifier . . . . .	EN-102
<b>Changing Settings</b>	<b>EN-103</b>
Changing the Upper1 Part Settings . . . . .	EN-103
Adjusting the Upper1 Part Volume . . . . .	EN-103
Changing the Upper2 Part Settings . . . . .	EN-104
Adjusting the Upper2 Part Volume . . . . .	EN-104
Fine-Tuning the Upper2 Part (Upper2 Detune) . . . . .	EN-104
Enabling/Disabling Upper2 Part Damper Pedal Effect . . . . .	EN-105
Changing the Lower Part Settings . . . . .	EN-106
Adjusting the Lower Part Volume . . . . .	EN-106
Fine-Tuning the Lower Part (Lower Detune) . . . . .	EN-106
Enabling/Disabling Lower Part Damper Pedal Effect . . . . .	EN-107
Saving the Digital Piano Settings (Auto Resume) . . . . .	EN-108
Restore Factory Defaults (Factory Reset) . . . . .	EN-109
Adjusting Volume Balance . . . . .	EN-110
Keyboard Volume . . . . .	EN-110
MIDI Song Volume . . . . .	EN-111
Audio Song Playback Volume . . . . .	EN-111
Wireless Audio Playback Volume . . . . .	EN-112
Center Cancel Function . . . . .	EN-113
Changing MIDI Settings . . . . .	EN-114
Local Control . . . . .	EN-114
Keyboard Channel . . . . .	EN-114
Hi-Res Velocity MIDI OUT . . . . .	EN-115
Main Digital Piano Settings . . . . .	EN-116
Power On Alert . . . . .	EN-116
Auto Power Off . . . . .	EN-116
Touch Button Luminosity . . . . .	EN-117
Left Panel Touch Button Sensitivity . . . . .	EN-117
Panel Lock . . . . .	EN-118
Switching Panel Light Settings . . . . .	EN-118
Notification Tone Volume . . . . .	EN-119
Notification Tone Set Selection . . . . .	EN-119
Volume Sync Equalizer . . . . .	EN-120
Speaker Out . . . . .	EN-120
Headphone Mode . . . . .	EN-121

---

<b>Troubleshooting</b>	<b>EN-122</b>
Error Display List . . . . .	EN-124
<b>Other Information</b>	<b>EN-128</b>
Product Specifications . . . . .	EN-128
Latest Support Information . . . . .	EN-132
About the Contents of this Manual . . . . .	EN-133
Trademarks and Registered Trademarks . . . . .	EN-133
Operating Precautions . . . . .	EN-134
<b>Various Lists</b>	<b>EN-136</b>
Tone list . . . . .	EN-136
Demo Song List . . . . .	EN-137
Music Library List . . . . .	EN-137
Keyboard Function List . . . . .	EN-139
MIDI Implementation Chart . . . . .	EN-145

# Overview of the Digital Piano

## Part Names and Functions

Illustration of AP-300.

Touch buttons

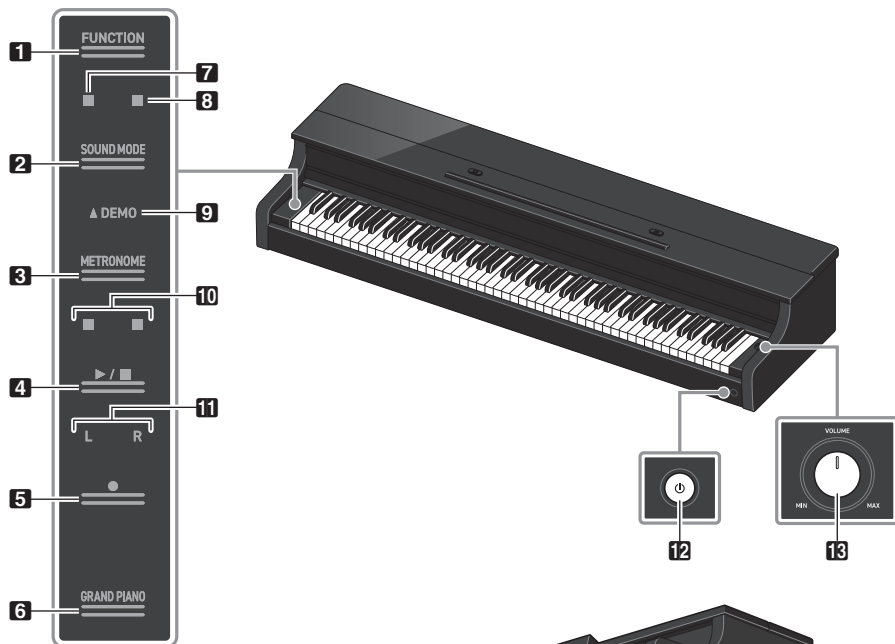

Bottom

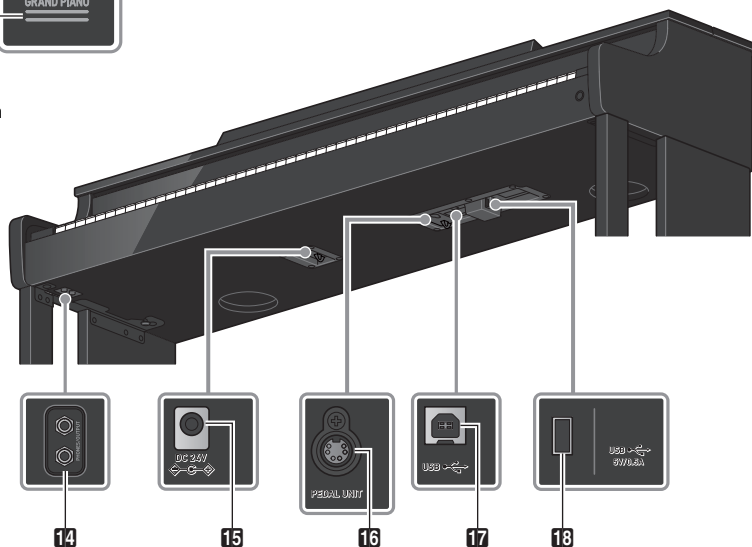

**1** FUNCTION button

Used for basic settings.

**2** SOUND MODE button

Used to change settings such as [SOUND MODE].

**3** METRONOME button

Used to turn the metronome On/Off.

**4** ►/■ button

Used to play/stop a song.

**5** ●(REC) button

Used to record performances.

**6** GRAND PIANO button

Sets the tone to <GRAND PIANO CONCERT>.

**7** Hall Simulator/Reverb Indicator

Lights up when [Hall Simulator/Reverb] is set to <On>.

**8** Surround Indicator

Lights up when [Surround] is set to <On>.

**9** DEMO Indicator

Lights up when a demo song is playing.

**10** Beat Indicator

The left side blinks on the first beat and the right side blinks on the remaining beats in time, such as when a song is playing.

**11** Track Indicator

During Record/Playback, “L” lights up to indicate the part of a track for the left hand, and “R” lights up to indicate the part of a track for the right hand.

**12** ⏻(Power) button

Turns main power On/Off. The outer circumference of the button indicates Bluetooth® connection status by the color of the light.

**13** Volume knob

Adjusts the volume of the Digital Piano.

**14** PHONES/OUTPUT jacks**15** Power supply terminal (DC 24V)**16** PEDAL UNIT jack**17** USB Type B port**18** USB Type A port



# Preparation Before Playing

## Preparing a Power Supply

Use the AC adaptor (JEITA standard, with unified polarity plug) supplied with the Digital Piano. Use of other AC adaptors may cause smoke or malfunction.

Model of AC adaptor included with the Digital Piano: AD-E24250LW

**Connect in the order of ① to ③ using the supplied power cord.**

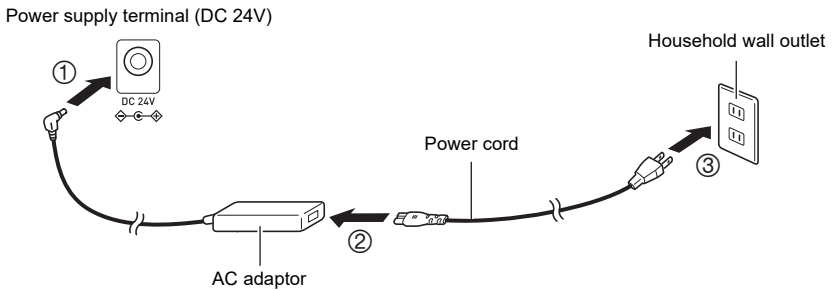

This AC adaptor cannot be repaired.

AC adaptor usage environment: Temperature 0 to 40°C, Humidity 10% to 90% RH

Output polarity:

### IMPORTANT!

- **Never connect the AC adaptor and power cord supplied with this Digital Piano to any other device. Doing so may cause malfunction.**
- **Be sure to turn the power off before unplugging and plugging in the AC adaptor.**
- **The AC adaptor will heat up slightly after prolonged use, this is not a malfunction.**
- **Unplug the AC adaptor from the power outlet when not using the digital piano for a long period of time.**

## Keyboard Cover

Be sure to open the keyboard cover completely before playing the Digital Piano.

### IMPORTANT!

- When opening and closing the keyboard cover, be careful not to get the hands or fingers of yourself and others (especially children) caught in the keyboard cover.
- Do not let go of the keyboard cover with your hands or fingers when opening or closing it.
- Do not press down on the keyboard cover with your hand when closing it (your hand may get caught in the gap of the keyboard cover).
- Do not place any objects on the keyboard cover. There is a risk that objects may get inside the product when opening the keyboard cover.
- Do not play with the keyboard cover partially open.

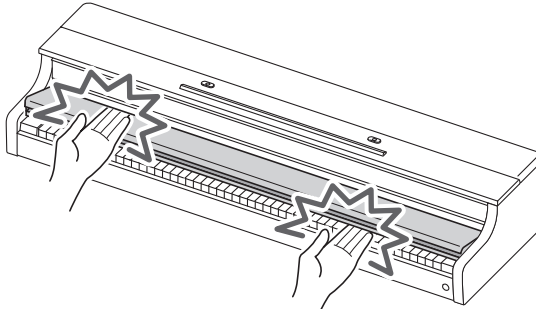

### Opening the Keyboard Cover

Place both hands in the recess of the keyboard cover, lift it up slightly, and push it back.

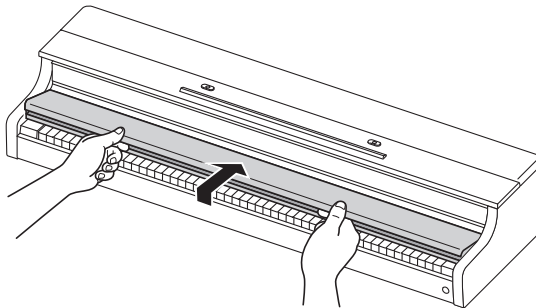

## Closing the Keyboard Cover

---

Place both hands in the recess of the keyboard cover and slowly pull it toward you until it is completely closed.

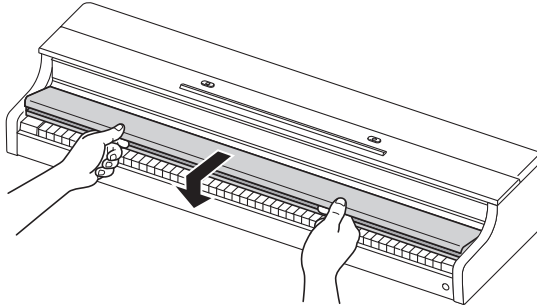

## Turning the Power On/Off

### Turning the Power On

#### 1. Press the “⏻ (Power)” button to turn the Digital Piano on.



- When the power is turned on, each touch button will blink while the Digital Piano is starting up. When all touch buttons are lit up, the Digital Piano is ready for use.
- The power may not come on after pressing the “⏻ (Power)” lightly, however, this is not a malfunction. If this happens, firmly press the “⏻ (Power)” button again.
- A pop may be heard when turning the power on and off, but this is not a malfunction.
- If the Digital Piano is turned on without the Wireless MIDI & audio adaptor attached, the outer edge of the “⏻ (Power)” button will flash blue to indicate that the Wireless MIDI & audio adaptor is not attached.

#### 2. Once the power is turned on, use the volume knob to adjust the volume.

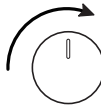

#### ■ Auto Power Off Function

After approximately 20 minutes of inactivity, the power automatically turns off to prevent unnecessary power consumption. To prevent the power turning off between performances at concerts, etc., set the [Auto Power Off] to <Off>.

For more information, see “[Auto Power Off](#)”.

#### ■ Power On Alert

After approximately 6 minutes without any operation, the “GRAND PIANO” button will turn lit and unlit at 5 second intervals to indicate that the power is still on. When an operation, such as touching a button or pressing a key, is performed, the Digital Piano will return to its normal state (all buttons lit up). You can switch the [Power On Alert] to operate or not.

For details, refer to “[Power On Alert](#)”.

## Turning the Power Off

Press and hold the “⏻(Power)” button for about 2 seconds.



### NOTE

- After the power is turned off using the “⏻(Power)” button, Digital Piano will still be in standby mode, with a small current flowing through it. Always disconnect the AC adaptor from the power outlet when you do not intend to use the Digital Piano for an extended period of time, or when there is a risk of a lightning strike.

### ■ Saving Settings when the Power is Turned Off (Auto Resume)

When the Digital Piano is turned off, various settings such as tone numbers are reset. If [Auto Resume] is set to <On>, most settings will be saved even when the power is turned off.

For more information, see “[Saving the Digital Piano Settings \(Auto Resume\)](#)”.

## Adjusting the Volume

The volume of the entire Digital Piano is controlled by the volume knob.



### ■ Automatically Correcting Sound Quality According to the Volume (Volume Sync Equalizer)

Automatically corrects the volume quality according to the volume output from the Digital Piano's speakers. You will be able to hear bass and treble clearly, even at low volumes.

For more information, see “[Volume Sync Equalizer](#)”.

### ■ Muting Sound from the Digital Piano's Speakers (Speaker Out)

If the [Speaker Out] setting is set to <Off>, no sound will be output from the speakers.

For more information, see “[Speaker Out](#)”.

## Using the Supplied Wireless MIDI & Audio Adaptor

To connect the Digital Piano to an external device that supports Bluetooth® wireless technology, attach the Wireless MIDI & audio adaptor to the USB Type A port.

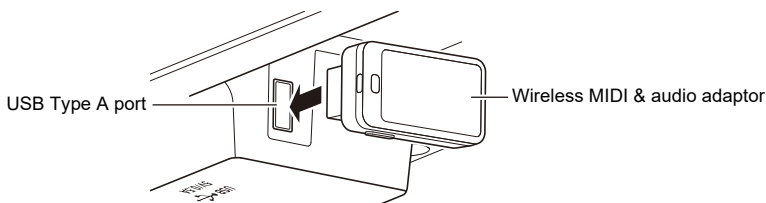

### ■ Connecting to Bluetooth Audio-Enabled Devices

By making a Bluetooth audio connection between this Digital Piano and a smart device, you can play sound from the smart device on this Digital Piano.

For more information, see “[Bluetooth Audio Connectivity](#)”.

### ■ Connecting to Bluetooth Low Energy MIDI-Enabled Devices

Bluetooth Low Energy MIDI connection\* between this Digital Piano and a smart device enables you to perform various operations using a dedicated app.

\* Operation is not guaranteed if used with apps other than CASIO's dedicated app.

For more information, see “[Bluetooth Low Energy MIDI Connectivity](#)”.

### ■ Using the Dedicated App (CASIO MUSIC SPACE)

Connect your smart device to the Digital Piano and use CASIO's dedicated app.

For more information, see “[Using the Dedicated App](#)”.

## IMPORTANT!

- When removing the Wireless MIDI & audio adaptor, turn the Digital Piano's power off.

## Using Headphones

Headphones allow you to enjoy playing at night without worrying about your surroundings. Turn down the volume on the Digital Piano before connecting headphones.

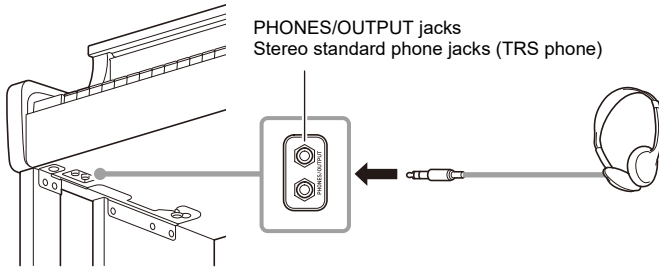

### **!** IMPORTANT!

- Do not use headphones for long periods of time at high volume. This may result in hearing impairment.
- If the headphone plug does not match the terminal, use a commercially available conversion plug.
- When unplugging the headphone cord from the Digital Piano, be careful not to leave the conversion plug in the Digital Piano. If the plug is left in place, no sound may be produced when playing.
- Use headphones (commercially available) that meet the following standards:  
**Maximum input: 150 mW or more**  
**Impedance: 32  $\Omega$  or more**

### ■ Headphone Mode

When using headphones, this reproduces the natural sound that reaches your ears when you play an acoustic piano.

For more information, see "[Headphone Mode](#)".

### ■ Sound from Speakers While Headphones are Connected

When the [Speaker Out] setting is set to <On>, sound will come out of the speakers even if a plug is inserted into the PHONES/OUTPUT jacks.

For more information, see "[Speaker Out](#)".

## Using the Music Stand

### AP-300

Insert the music stand legs into the two holes on the top surface of the main Digital Piano housing.

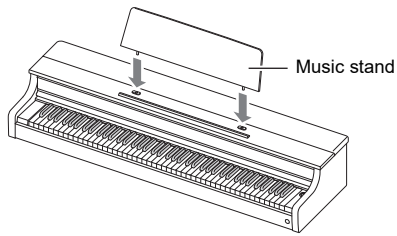

### AP-S200

Insert the music stand legs into the two holes on the top surface of the main Digital Piano housing.

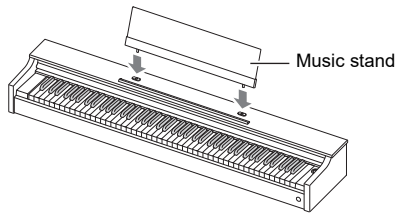



## The Top Panel of the Digital Piano (AP-300 only)

### IMPORTANT!

- Always open and close the top panel with both hands and be careful not to get your fingers caught.
- Do not force the top panel to open further backward. This may cause damage.
- Stand to the right of the Digital Piano to open and close the top panel.

### Opening the Top Panel of the Digital Piano

1. Lift the top panel.

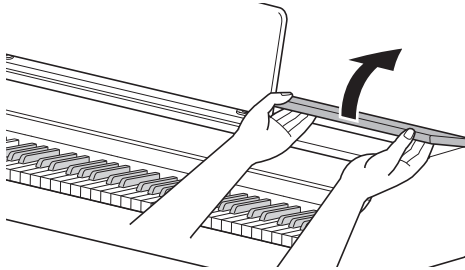

2. Check that the metal fittings that support the top panel are upright inside the top panel.

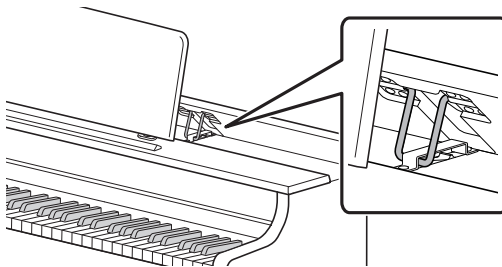

## Closing the Top Panel of the Digital Piano

1. Lift the top panel gently upward.

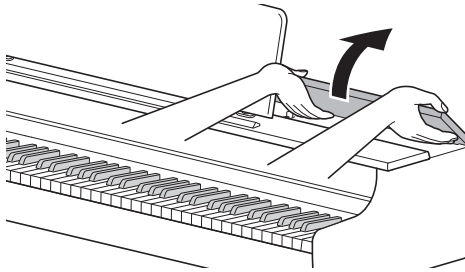

2. Slowly lower the top panel while pushing the metal fittings supporting the top panel backward with your fingers.



- To prevent the top panel from closing too vigorously, the metal fittings may temporarily stop in the middle area. When this happens, once again slowly lower the top panel while pushing the metal fittings backward with your fingers.

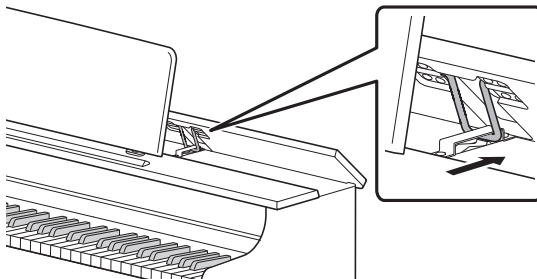

# Read This First (Basic Operations and Settings)

## Notation in this Manual

### ■ Notation of Function Names and their Setting Options

This manual describes how to make settings for the various functions. To make it easier to distinguish between the names of functions and the setting options for those functions, the names of functions are enclosed in [ ], and the setting options for those functions are enclosed in < >.

#### Example:

Switch the [Recorder] setting to <MIDI Recorder>.

- Recorder: Function Name
- MIDI Recorder: One of the options of the Recorder function

### ■ Notation of Note Names and Pitches on the Keyboard

Note names and pitches on the keyboard are indicated by the international representation (Middle C = "C4"), with the lowest C key named "C1" and the highest C key named "C8".

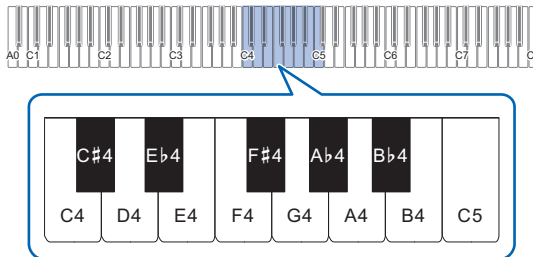

## Touch Button Operation

When the Digital Piano is turned on, the touch buttons on the left hand panel light up. After no operation for 15 seconds, the lights on the left panel go off. When the lights are off, the touch buttons will light up again if you touch the left panel.

You can change the number of seconds before the lights go off on the left panel or set up the lights to not go off.

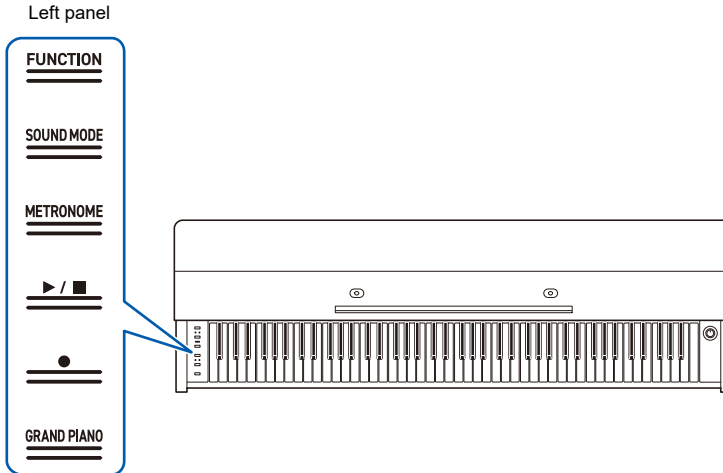

For more information, see “[Switching Panel Light Settings](#)”.



### IMPORTANT!

- When operating the touch buttons, touch them firmly with bare fingers. There is no response to gloved fingers.
- Only the touch buttons that are active at the time will light up.

#### ■ When Touch Buttons Do Not Respond

1. Turn off the power to the Digital Piano.
2. While pressing the C8 key (rightmost key), press the “ (Power)” button.
  - Do not release the C8 key until the Digital Piano is turned on and the touch buttons start to blink. You can release the “ (Power)” button.
  - The sensitivity of the touch buttons is set to high.

## Operation of the Touch Buttons Alone

Touching a button (touch firmly with fingertip and release immediately) will execute the function of that button.

Button	Function
SOUND MODE	Switches between <On> and <Off> for [Hall Simulator/Reverb] and [Surround].
METRONOME	The metronome starts (or stops).
▶/■	Plays/Stops songs and recordings.
●(REC)	Use to record performances.
GRAND PIANO	Selects <GRAND PIANO CONCERT> tone.

- The “FUNCTION” button only executes a function when used in combination with the keyboard or with the “SOUND MODE” button. The “FUNCTION” button on its own does not execute any function.

## Touch Button and Keyboard Combination Operation

By using the touch buttons (except for the “●(REC)” button) and the keyboard at the same time, you can change various settings.

- The items to be set vary depending on the touch button pressed.
- The type of keyboard operation differs depending on the item you are setting.
- There are five operation types as set out below:

### ■ Selecting a Setting Value Directly (operation type A)

- Select the setting value assigned to the key.

#### Example: Selecting a tone

While holding down the “GRAND PIANO” button, press one of the G3 to C#5 keys (Tone Selection).

- See “[Tone list](#)” for the tones available for each key.

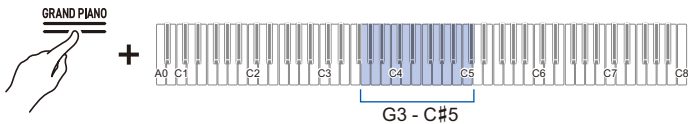

**Using the +/- Keys to Raise or Lower the Setting Value by 1 (operation type B)**

- Holding down a key changes the setting value continuously in increments.
- Pressing two keys together will return the value to the initial setting (default value).

**Example: Setting the tempo**

While holding down the “METRONOME” button, press the B2 key (tempo -)/C3 key (tempo +).

- This raises or lowers the tempo setting by 1.

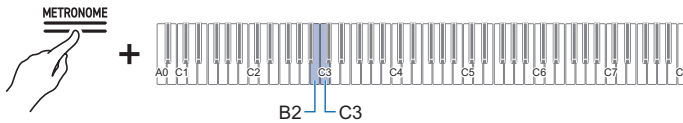

**Inputting Setting Values Using the Keys 0 to 9 (operation type C)**

- For example, to enter “2”, press the “2” keyboard key. To enter “20”, press the “2” keyboard key followed by the “0” keyboard key.

**Example: Setting the tempo**

While holding down the METRONOME button, press a key from A0 to F#1 (tempo value setting).

- Sets the tempo in the range of 20 to 255 (beats per minute).

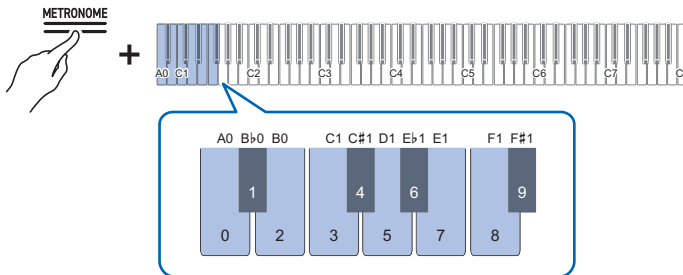

## ■ Switching On/Off or Changing Setting Values Using a Single Key (operation type D)

- Each time the key is pressed, the setting is changed.
- When the key is pressed, a sound is played according to the set value.

### Example: Locking button operations

While holding down the “FUNCTION” button, press the C8 key (Panel Lock).

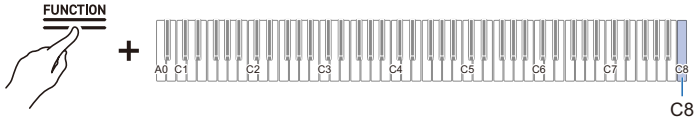

- For more information, see “[Panel Lock](#)”.

## ■ Putting in Standby Mode, and Executing on Next Key Press (operation type E)

### Example: Performing a Factory Reset

1. While holding down the “FUNCTION” button, press the A0 key (Factory Reset) to enter standby mode.

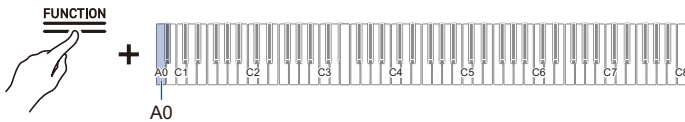

- To execute the process, do not release the touch button, and perform the operation in step 2.
- If the touch button is released in standby mode, the function will not be executed (the operation will be canceled).

2. Hold down the “FUNCTION” button and press the C1 key (Execute) to execute the process.

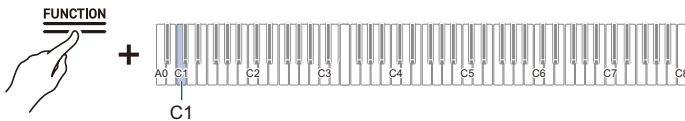

- After performing step 2, release the touch button.
- Processing may take some time. If so, wait until the process is complete.

### NOTE

- When a touch button and keyboard keys are operated in combination, a notification tone sounds to inform the user of the result of the operation.
- For details, see “[Notification Tones](#)”.

## Notification Tones

When the touch buttons and keyboard are operated in combination, a notification tone sounds when the key is pressed to inform the user of the result of the operation.

### Notification Tone Types

Notification Tone Type	Details of Notification
Tone for Accept	This is the sound made when a keyboard operation is accepted. Rings when the setting is turned on for setting items that toggle between on and off.
Tone for Invalid	This is the sound made when the wrong key is pressed. Keyboard operation is invalid when this tone sounds.
Tone for Upper and Lower Limits	This sound is made when the upper or lower limit of the set value is exceeded. Keyboard operation is invalid when this tone sounds.
Tone for Default Settings	This sound is made when the settings are returned to their default values. This sounds when the + and – keys are pressed at the same time, for example.
Tone for number notification	When one key is pressed continuously to toggle to a different setting value, the current setting value is indicated by the number of times the notification tone sounds.
Tone for Off	This is the sound made when the setting is switched off.
Separator Tone	This sound is made when the + or – key is used to increase or decrease a setting value and the number reaches a multiple of that value. For whole number-only settings a notification tone will sound each time the number is a multiple of 10. For a setting with a decimal value (e.g., 440.2), a notification tone sounds for whole numbers (e.g., 440 or 441).
Tone for Setting Completion	If multiple key presses are required to complete a setting, this notification tone will sound when the setting is complete. For example, when entering a 3-digit tempo value, this notification tone will sound when the third digit key is pressed and the setting is complete.

### ■ Changing Notification Tone Settings

You can choose one of three different notification tone sets and adjust the volume of the notification tones.

For more information, see [“Notification Tone Set Selection”](#) and [“Notification Tone Volume”](#).



# Listening to the Demo Songs

## Playing the Demo Songs

Hold down the “FUNCTION” button and press the “SOUND MODE” button.

- Playback of the demo song will start. Refer to the “[Demo Song List](#)” for a list of the songs.
- When the demo song end, songs from the Music Library will play continuously from the second song onward. See “[Music Library List](#)” for song listings.

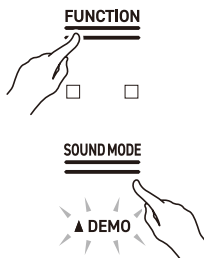

### NOTE

- While the [Auto Power Off] setting is <On>, the power will turn off within a certain period of time after the entire demo performance.

## Operations Possible during Demo Song Playback

You can change the song or [Sound Mode] Effects during demo song playback.

### ■ Skipping to Previous/Next Song

While holding down the “▶/■” button, press the B2 key (Song Select –)/C3 key (Song Select +).

[Using the +/- Keys to Raise or Lower the Setting Value by 1 \(operation type B\)](#)

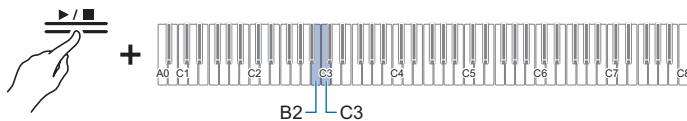

### ■ Skip to Specific Song

While holding down the “▶/■” button, press the A0 key (demo song) or one of the C#3 to C8 keys (Music Library Built-in Songs).

[Selecting a Setting Value Directly \(operation type A\)](#)

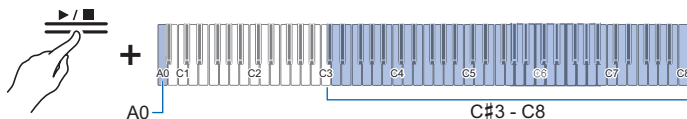

## ■ Changing the Sound Mode Effects

You can switch between <On> and <Off> for [Hall Simulator/Reverb] and [Surround].

[Using Sound Mode Effects \(Hall Simulator/Reverb and Surround\)](#)

## Ending the Playback of Songs

**Touch the “▶/■” button.**

- Touch buttons that were unlit while the songs were playing will light again.



# Playing

## Selecting a Tone

The Digital Piano has 18 built-in tones for all keys, including a grand piano tone scheme, and one bass tone scheme dedicated to the bass section.

- The tone names are marked above the keys.

For more information, see [“Using the Keyboard to Select a Tone”](#).

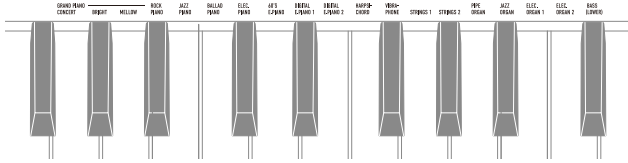

- In addition to selecting a single tone to play across the keyboard, two tones can be played on top of each other (Layer), and the bass tone can be assigned to the bass section.

For details, see [“Layering Two Tones \(Layer\)”](#) and [“Splitting Left and Right Keys \(Split\)”](#).

### ■ Grand Piano Tone Features

The list below shows grand piano tones. These tones are both powerful and strong, with a wide range of dynamic expression, with an elegant and glossy sound that is loved by many pianists.

Tone name	Characteristic
GRAND PIANO CONCERT	A full concert grand piano tone with dynamic and natural tone changes.
GRAND PIANO BRIGHT	A bright and clear piano tone.
GRAND PIANO MELLOW	A warm and calm piano tone.

## Selecting a Single Tone

### ■ Using the Keyboard to Select a Tone

Hold down the “GRAND PIANO” button and press one of the G3 to C#5 keys.

Selecting a Setting Value Directly (operation type A)

- See “Tone list” for the tones available for each key.

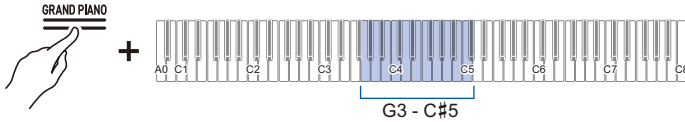

### Selecting Tones in the Order of the Tone List

While holding down the “GRAND PIANO” button, press the B2 or C3 key.

Using the +/- Keys to Raise or Lower the Setting Value by 1 (operation type B)

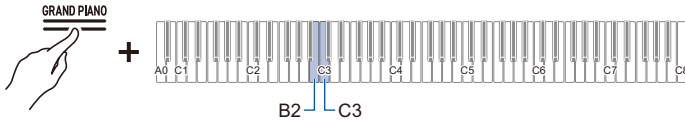

Key	Setting
B2	Selects the previous tone (-)
C3	Selects the next tone (+)

### ■ Using the Touch Button to Select a Tone

Touch the “GRAND PIANO” button.

- The GRAND PIANO CONCERT tone is selected.



#### **NOTE**

- Selecting a tone with this operation while [Layer] is <On> will result in [Layer] switching to <Off>.

## Layering Two Tones (Layer)

You can have two tones sounding simultaneously when playing the keyboard. Since the tones are layered over each other, this feature is called Layer. The first tone selected is called the Upper1 part tone and the second tone selected is called the Upper2 part tone. When [Layer] is set to <On>, Upper1 and Upper2 parts will both sound at the same time.

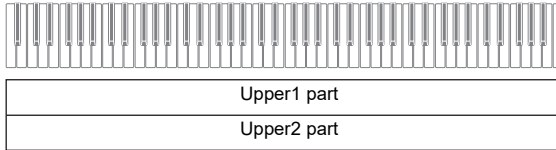

### ■ Turning Layer On/Off

While holding down the “GRAND PIANO” button, press the C7 key (Layer).

Switching On/Off or Changing Setting Values Using a Single Key (operation type D)



- Default value: Off

Setting Value	Setting Details
Off	Turns Layer off.
On	Turns Layer on.

### NOTE

- You can also touch the “GRAND PIANO” button to turn [Layer] <Off>.

## ■ Selecting the Upper2 Part Tone

You can select the Upper2 part tone when [Layer] is set to <On>.

1. Turn [Layer] <On>.
2. While holding down the “GRAND PIANO” button, press one of the G3 to C5 keys to select the tone for the Upper2 part.

[Selecting a Setting Value Directly \(operation type A\)](#)

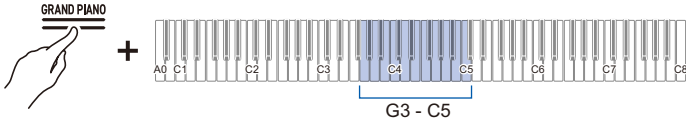

### NOTE

- Upper1 Part tones can be selected when [Layer] is <Off>.

## ■ Changing the Upper1 Part Settings

You can adjust the Upper1 part volume and perform octave shift.

For details, see [“Changing the Upper1 Part Settings”](#) and [“Shifting Upper1 Part by an Octave”](#).

## ■ Changing the Upper2 Part Settings

You can adjust the Upper2 part volume and perform octave shift.

For details, see [“Changing the Upper2 Part Settings”](#) and [“Shifting Upper2 Part by an Octave”](#).

## Splitting Left and Right Keys (Split)

You can select a tone dedicated to the bass section <BASS (LOWER)> to play bass notes in the bass section of the keyboard. This usage is called Split, since the entire keyboard is split into left and right. The tone of the bass section is called Lower Tone Section, and the tone of the treble section is called Upper1 Tone Section.

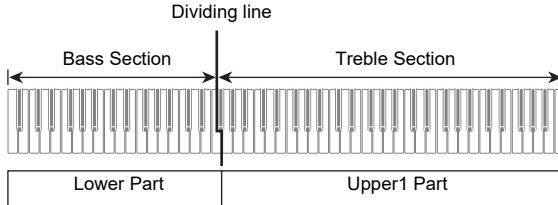

### ■ Selecting a Tone Exclusively for the Bass Section

While holding down the “GRAND PIANO” button, press the C#5 key (BASS).

Selecting a Setting Value Directly (operation type A)

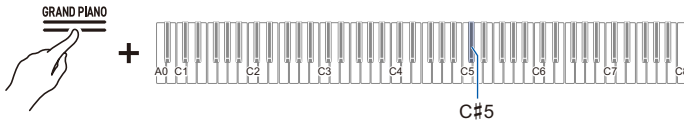

- Only the bass section of the keyboard (left side) will have the BASS tone, while the treble section (right side) will remain the same as the previously selected tone.
- Selecting a tone other than the BASS tone will cancel the split state.

### ■ Changing the Lower Part Settings

You can change the volume and other settings for the Lower Part.

For more information, see “[Changing the Lower Part Settings](#)”.

### ■ Changing the Upper1 Part Settings

You can adjust the volume and perform Upper1 octave shift.

For details, see “[Changing the Upper1 Part Settings](#)” and “[Shifting Upper1 Part by an Octave](#)”.

# Splitting the Keyboard into Left and Right for Two-Person Performance (Duet)

## What is a Duet?

You can have the same pitch range on the right and left sides from the center of the keyboard. This can be used when a teacher plays a model performance on the left side and the student plays the same melody on the right side. In addition, you can change the pitch range of the left and right keys by octaves.

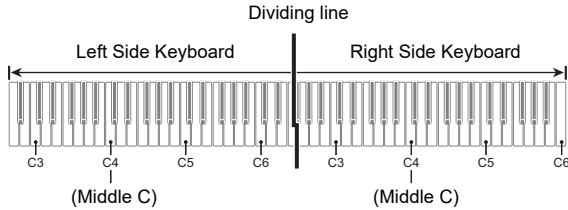

## ■ Pedal Operation for Duets (On/Pan)

The pedals at both ends are damper pedals for the left and right keys respectively, and the center pedal is a damper pedal for both the left and right keys.

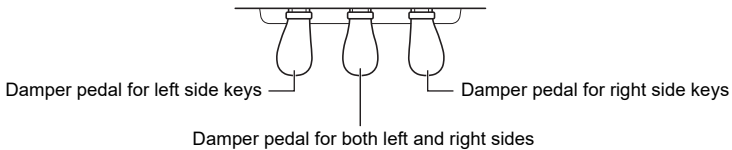



## Using the Duet Function

While holding down the “**FUNCTION**” button, press the **F2** key (Duet Mode).

Switching On/Off or Changing Setting Values Using a Single Key (operation type D)

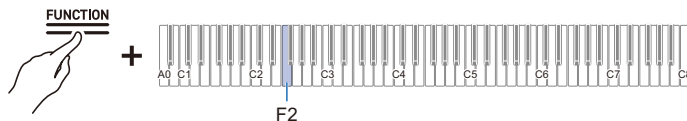

- Default value: Off

Setting Value	Notification Tone	Setting Details
Off	Tone for Off	Turns off Duet.
On	1 notification tone	Turns on Duet.
Pan	2 notification tones	The sound of the left keyboard is output from the left speaker only, and the sound of the right keyboard is output from the right speaker only.

### NOTE

- Some settings cannot be changed while the [Duet] function is in use.
- When the [Duet] function is set to <Pan>, [Acoustic Simulator], [Hall Simulator/Reverb], [Surround] and [Chorus] are not available.

## Changing the Pitch Range

For both the left and right keyboard, the range can be changed from -2 to +2 octaves.

**While holding down the “FUNCTION” button, press the corresponding key.**

Using the +/- Keys to Raise or Lower the Setting Value by 1 (operation type B)

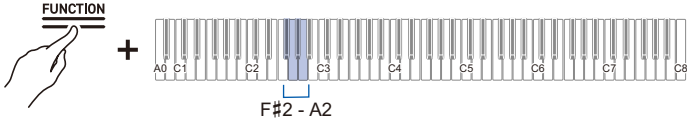

### Left-Side Keyboard Settings

- Setting value: -2 octaves to +2 octaves
- Default value: 0

Key	Setting
F#2	Lowers the range by one octave (-)
G2	Raises the range by one octave (+)
F#2 + G2	Resets the range to the default setting.

### Right Side Keyboard Setting

- Setting value: -2 octaves to +2 octaves
- Default value: 0

Key	Setting
A♭2	Lowers the range by one octave (-)
A2	Raises the range by one octave (+)
A♭2 + A2	Resets the range to the default setting.

### Example of Setting Range

When the G2 key is pressed once

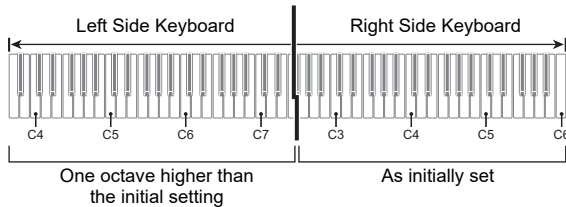

## Using the Pedals

There are three pedals: Damper, Soft, and Sostenuto. You can enjoy expressive performances that feel closer to that of a grand piano using the pedals.

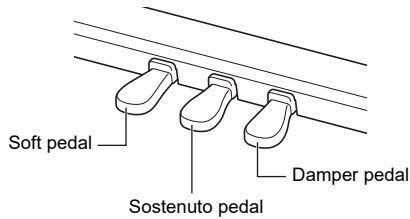

### ■ Damper Pedal

Pressing the damper pedal while playing will cause the notes you play to be sustained. When a grand piano tone is selected, you can also create a resonance effect (Damper Resonance) similar to when using a damper pedal on an acoustic grand piano. The pedal also supports half-pedal operation, so pressing the pedal part way applies only a partial damper effect.

### ■ Soft pedal

Pressing this pedal while playing suppresses notes played on the keyboard after the pedal was pressed, and makes them sound softer. The AP-300 supports half-pedal operation.

### ■ Sostenuto Pedal

Only the notes of the keys that are depressed when this pedal is pressed are sustained, even if the keyboard keys are released, until the pedal is released.

# Using the Metronome

## Metronome On/Off

The metronome beats at regular intervals. Using the metronome allows you to practice playing at a constant tempo. As soon as the metronome starts, the beat indicators light up in time with the beat and tempo.

### 1. Touch the “METRONOME” button. The metronome will start.

- The beat indicator lights up in time with the metronome beat (left side for the first beat, right side for the remaining beats).



### 2. To stop the metronome, touch the “METRONOME” button again.

## Setting the Beat

While holding down the “METRONOME” button, press any one of the C#3 to B♭3 keys.

Selecting a Setting Value Directly (operation type A)

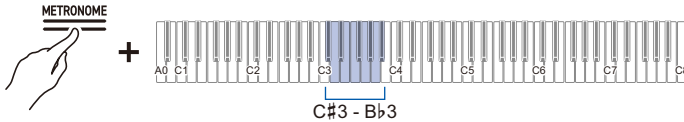

- Default value: 4

Key	Setting Value	Setting Details
C#3	Off	Only a click sounds on each beat.
D3	1	A bell tone sounds on each beat.
E♭3	2	Sets the number of beats per bar to between 2 and 9. A bell tone sounds on the first beat, and a click sound is heard on each remaining beat.
E3	3	
F3	4	
F#3	5	
G3	6	
A♭3	7	
A3	8	
B♭3	9	

## Setting a Tempo

### ■ Entering Tempo as a Number

Set the tempo for the metronome or song playback within the range of 20 to 255 (beats per minute). While holding down the METRONOME button, use the A0 to F#1 keys (tempo value setting) to enter the tempo setting value.

[Inputting Setting Values Using the Keys 0 to 9 \(operation type C\)](#)

### ■ Raising or Lowering the Tempo Value by 1

While holding down the “METRONOME” button, press the B2 key (tempo -)/C3 key (tempo +).

[Using the +/- Keys to Raise or Lower the Setting Value by 1 \(operation type B\)](#)

### ■ Setting the Tempo from a Tempo Marking

Choose from a tempo marking such as Andante or Allegro.

While holding down the “METRONOME” button, press one of the C2 to Ab2 keys (tempo marking setting).

[Selecting a Setting Value Directly \(operation type A\)](#)

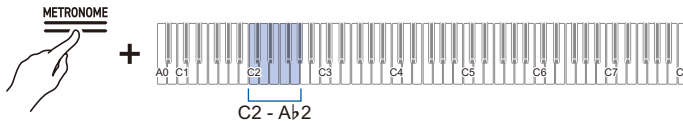

Key	Tempo Marking Setting	Tempo (beats per minute)
C2	Largo	46
C#2	Lento	52
D2	Adagio	56
Eb2	Andante	72
E2	Moderato	96
F2	Allegretto	108
F#2	Allegro	132
G2	Vivace	160
Ab2	Presto	184

## ■ Setting the Tempo Yourself by Tapping a Key (Tap Tempo)

While holding down the “METRONOME” button, press the B♭2 key (Tap Tempo) two or more times in succession.

- The tempo will be based on the interval between your key taps.

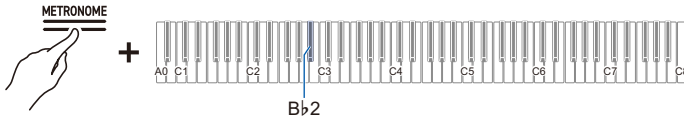

## Adjusting the Volume

While holding down the “METRONOME” button, press the A1 or B♭1 key.

Using the +/- Keys to Raise or Lower the Setting Value by 1 (operation type B)

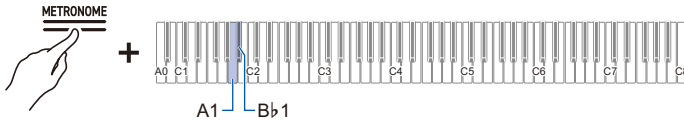

- Setting value: 0 (silence) to 42 (maximum volume)  
A separator tone sounds when the set value becomes a multiple of 10.
- Default value: 25

Key	Setting
A1	Decreases volume by 1 (-)
B♭1	Increases the volume by 1 (+)
A1 + B♭1	Resets volume to default setting

# Applying Effects to Sound

## Using Sound Mode Effects (Hall Simulator/Reverb and Surround)

Each time the “SOUND MODE” button is touched, effects are switched on and off in turn.

### ■ Hall Simulator/Reverb

This effect adds reverberation to the sound.

#### Hall Simulator

This effect simulates the different acoustic characteristics of world-famous concert halls and buildings.

#### Reverb

This reproduces the reverberation of a given space, such as a room or a hall.

### ■ Surround

Surround sound (spread effect) is applied to the output sound from the Digital Piano speakers.

## Turning on/off Hall Simulator/Reverb and Surround

**Touch the “SOUND MODE” button.**

- Each time you touch the button, the indicators above the button will become lit or unlit as shown below.

<input type="checkbox"/> <b>SOUND MODE</b>	<input type="checkbox"/> <b>SOUND MODE</b>	<input type="checkbox"/> <input type="checkbox"/> <b>SOUND MODE</b>	<input type="checkbox"/> <b>SOUND MODE</b>
Hall Simulator/Reverb <ON>	Hall Simulator/Reverb <OFF>	Hall Simulator/Reverb <ON>	Hall Simulator/Reverb <OFF>
Surround <OFF>	Surround <ON>	Surround <ON>	Surround <OFF>



## Selecting Hall Simulator/Reverb Presets

While holding down the “**SOUND MODE**” button, press any one of the **A0** to **E1** keys.

Selecting a Setting Value Directly (operation type A)

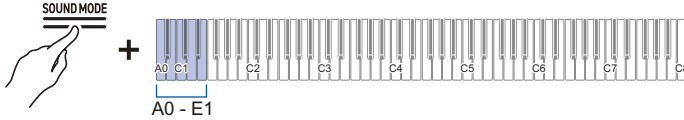

- Default value: Hall

### ■ Hall Simulator

Key	Type	Setting Details
A0	N.Y. Club	Music club in Manhattan
B♭0	Opera Hall	The uniquely shaped Sydney concert hall
B0	Berlin Hall	An arena-style classical concert hall in Berlin
C1	British Stadium	Large outdoor stadium in the outskirts of London

### ■ Reverb

Key	Type	Setting Details
C#1	Room	Reverb that gives a sense of reverberation within a room
D1	Large Room	
E♭1	Hall	Reverb that emulates reverberation in a small hall
E1	Stadium	Reverb that emulates reverberation within a stadium

## Adjusting Applied Hall Simulator/Reverb

While holding down the “**SOUND MODE**” button, press the corresponding key.

Using the +/- Keys to Raise or Lower the Setting Value by 1 (operation type B)

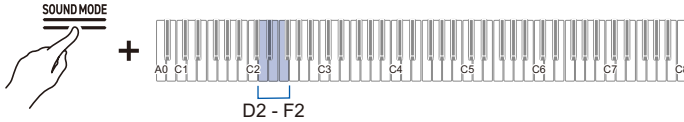

- Setting value: 0 (no effect) to 42 (maximum depth)  
A separator tone sounds when the set value becomes a multiple of 10.

Key	Setting
D2	Reduces the depth of effect applied to built-in sound sources by 1 (-)
E $\flat$ 2	Increases the depth of effect applied to built-in sound sources by 1 (+)
D2+E $\flat$ 2	Resets the depth of effect to the default setting for built-in sound sources (default value: 21)
E2	Decreases the depth of effect on the wireless audio input signal by 1 (-)
F2	Increases the depth of effect on the wireless audio input signal by 1 (+)
E2+F2	Resets the depth of effect to the default setting for the wireless audio input signal (default value: 0)

## Using Chorus

[Chorus] layers sounds to add depth.

**While holding down the “SOUND MODE” button, press one of the C7 to E7 keys.**

Selecting a Setting Value Directly (operation type A)

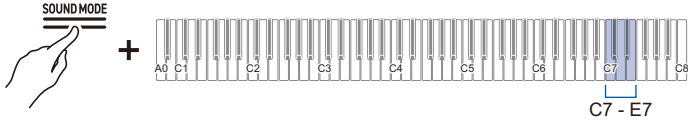

- Default value: Tone

Key	Setting Value	Setting Details
C7	Tone	Automatically selects the chorus type appropriate for the current tone.
C#7	Light Chorus	Applies a thin chorus effect.
D7	Chorus	Applies a medium chorus effect.
Eb7	Deep Chorus	Applies a deep chorus effect.
E7	Flanger	Applies a flanger (an effect that swells the sound).

## Adjusting Brilliance

[Brilliance] allows you to adjust the brightness of the sound.

**While holding down the “SOUND MODE” button, press the B2 or C3 key.**

Using the +/- Keys to Raise or Lower the Setting Value by 1 (operation type B)

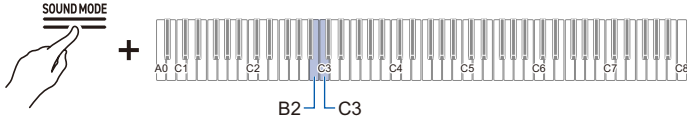

- Setting value: -12 to +12
- When set to +1 or higher, the sound is brighter, and when set to -1 or lower, the sound is mellower.
- Default value: 0

Key	Setting
B2	Decreases the brilliance setting by 1 (-)
C3	Increases the brilliance setting by 1 (+)
B2+C3	Restores brilliance to default settings.

## Adjusting the Sound Characteristics of the Acoustic Piano Presets (Acoustic Simulator)

The piano tones of this Digital Piano have built-in elements that characterize the sound of an acoustic piano. Each of the tone characteristics can be adjusted.

### Setting String Resonance

When playing acoustic piano, the strings, which are the overtones of the keys you play, resonate. Adjust the resonance by setting [String Resonance].

**While holding down the “SOUND MODE” button, press one of the C#3 to F#3 keys.**

Selecting a Setting Value Directly (operation type A)

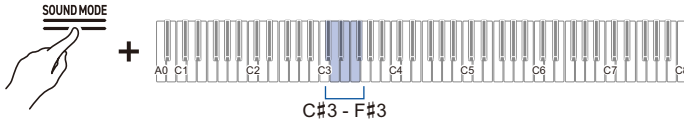

- Default value: Tone

Key	Setting Value	Setting Details
C#3	Tone	Automatically sets a value appropriate for the current tone.
D3	Off	Disables String Resonance.
Eb3	1	The larger the number, the stronger String Resonance effect.
E3	2	
F3	3	
F#3	4	

## Setting Damper Resonance

When pressing the damper pedal of an acoustic piano, the strings of all 88 keys are released, meaning all the strings that are harmonics of the played keys resonate. Adjust the degree of resonance by setting [Damper Resonance].

**While holding down the “SOUND MODE” button, press one of the G3 to C4 keys.**

Selecting a Setting Value Directly (operation type A)

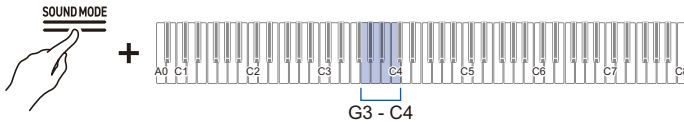

- Default value: Tone

Key	Setting Value	Setting Details
G3	Tone	Automatically sets a value appropriate for the current tone.
A♭3	Off	Disables Damper Resonance.
A3	1	The larger the number, the stronger the Damper Resonance effect.
B♭3	2	
B3	3	
C4	4	

## Setting Damper Noise

When pressing the damper pedal on an acoustic piano, a small noise is produced when the damper moves away from the piano wire. Adjust the volume of the noise by setting [Damper Noise].

**While holding down the “SOUND MODE” button, press one of the C#4 to F#4 keys.**

Selecting a Setting Value Directly (operation type A)

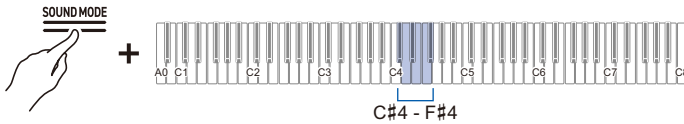

- Default value: Tone

Key	Setting Value	Setting Details
C#4	Tone	Automatically sets a value appropriate for the current tone.
D4	Off	No Damper Noise is made.
Eb4	1	The higher the number, the louder the noise.
E4	2	
F4	3	
F#4	4	

## Setting Key On Action Noise

When playing the keys very softly on an acoustic piano, the hammers do not reach the strings and only the mechanical action (noise) of the piano is heard. Adjust the volume of the noise by setting [Key On Action Noise].

**While holding down the “SOUND MODE” button, press one of the G4 to C5 keys.**

Selecting a Setting Value Directly (operation type A)

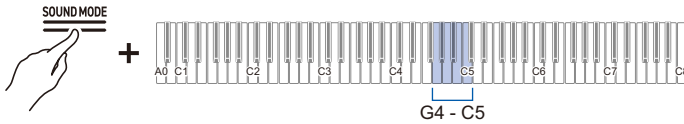

- Default value: Tone

Key	Setting Value	Setting Details
G4	Tone	Automatically sets a value appropriate for the current tone.
A $\flat$ 4	Off	No Key On Action Noise made
A4	1	The higher the number, the louder the noise.
B $\flat$ 4	2	
B4	3	
C5	4	



## Setting Key Off Action Noise

When a finger is removed from the keyboard of an acoustic piano, this generates mechanical piano action (noise). Adjust the volume of the noise by setting [Key Off Action Noise].

**While holding down the “SOUND MODE” button, press one of the C#5 to F#5 keys.**

Selecting a Setting Value Directly (operation type A)

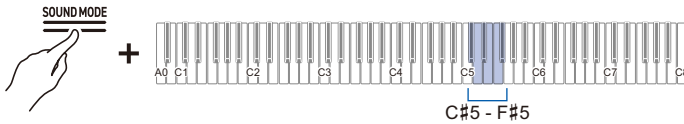

- Default value: Tone

Key	Setting Value	Setting Details
C#5	Tone	Automatically sets a value appropriate for the current tone.
D5	Off	No Key Off Action Noise is made.
E♭5	1	The higher the number, the louder the noise.
E5	2	
F5	3	
F#5	4	

## Setting Lid Simulator (AP-300 only)

The sound of a grand piano changes depending on how open the lid is. With this Digital Piano, when you adjust the opening of the lid using the [Lid Simulator], the change in sound is simulated using digital processing. (The Lid Simulator is unrelated to the top panel opening/closing mechanism of the housing.)

**While holding down the “SOUND MODE” button, press one of the G5 to B5 keys.**

Selecting a Setting Value Directly (operation type A)

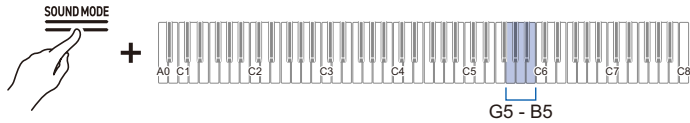

- Default value: Tone

Key	Setting Value	Setting Details
G5	Tone	Automatically sets a value appropriate for the current tone.
A $\flat$ 5	Close	The lid is closed.
A5	Semi	The lid is slightly open.
B $\flat$ 5	Full	The lid is fully open.
B5	Remove	The lid is removed.

## Adjusting Key Touch

### Changing the Volume Made by the Strength of Pressure Placed on a Key (Touch Response)

The [Touch Response] function changes the volume according to the strength (speed) with which a player presses a key. The [Touch Response] function enables the volume and sound quality to change according to the strength (speed) with which a player presses a key, just like an acoustic piano, enriching the expression of performances.



Press quickly to produce a loud sound.

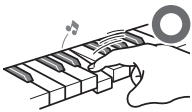

Press slowly to produce a quiet sound.



Do not press too vigorously.

## Changing the Sensitivity of Touch Response

While holding down the “GRAND PIANO” button, press one of the Eb1 to Ab1 keys.

Selecting a Setting Value Directly (operation type A)

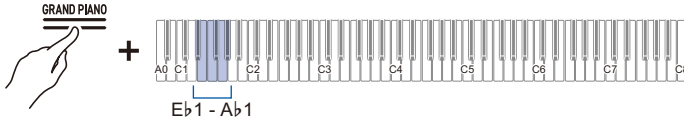

- Default value: 3

Key	Setting Value	Setting Details
Eb1	Off	Cancels Touch Response. The volume remains constant even when key pressing speed changes.
E1	1 (Light)	This setting makes it easier to produce loud sounds, and the touch feels lighter than “Normal”.
F1	2 (Medium light)	
F#1	3 (Normal)	Standard setting.
G1	4 (Medium heavy)	This setting makes it difficult to produce loud sounds, and the touch feels heavier than “Normal”.
Ab1	5 (Heavy)	

# Adjusting the Pitch of Sound

## Changing the Pitch in Semitone Steps (Transpose)

Raise or lower the overall pitch of all notes in semitone steps. This is useful when you want to play a difficult key in a familiar key, or when you want to raise or lower the key of the accompaniment to match the pitch of a singer's voice.

### Transpose

While holding down the “GRAND PIANO” button, press the C#1 or D1 key.

Using the +/- Keys to Raise or Lower the Setting Value by 1 (operation type B)

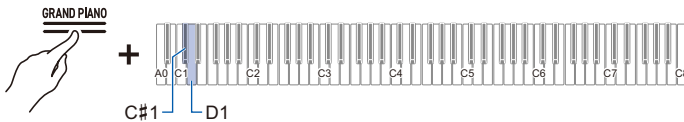

- Setting value: -12 to +12 semitones
- Default value: 0

Key	Setting
C#1	Lowers the pitch of all notes by a semitone (-)
D1	Raises the pitch of all notes by a semitone (+)
C#1 + D1	Resets the pitch of all notes to default setting

## Fine-tuning (A-tuning)

Shift the overall pitch of the instrument slightly. Set the frequency of the A4 note in the range of 415.5 to 465.9 Hz (default 440.0 Hz).

### Tuning

#### ■ Select 440.0 Hz or 442.0 Hz

While holding down the “FUNCTION” button, press the A4 or B $\flat$ 4 key.

Selecting a Setting Value Directly (operation type A)

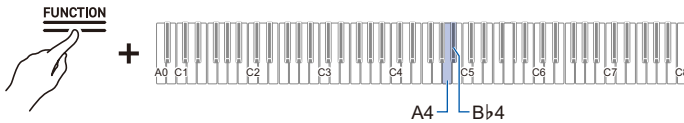

- Default value: 440.0 Hz

Key	Setting
A4	Sets the frequency of the A4 note to 440.0 Hz
B $\flat$ 4	Sets the frequency of the A4 note to 442.0 Hz

#### ■ Changing in 0.1 Hz Increments

While holding down the “FUNCTION” button, press the B4 or C5 key.

Using the +/- Keys to Raise or Lower the Setting Value by 1 (operation type B)

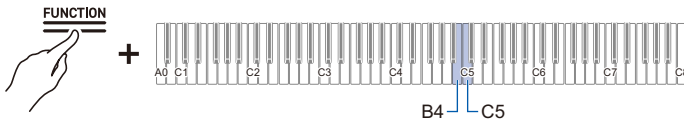

- Set value: 415.5 to 465.9 Hz  
A separator tone sounds when the frequency reaches a whole number (such as 440 or 441).
- Default value: 440.0 Hz

Key	Setting
B4	Decreases the frequency of the A4 note by 0.1 Hz (-)
C5	Raises the frequency of the A4 note by 0.1 Hz (+)

## Shifting by Octaves (Octave Shift)

The pitch of the sound can be raised or lowered in octaves.

Each part (Upper1 and Upper2) can be set independently when using [Layer].

For more information about layers and their respective parts, see “[Layering Two Tones \(Layer\)](#)”.

### Shifting Upper1 Part by an Octave

While holding down the “GRAND PIANO” button, press the B0 or C1 key.

Using the +/- Keys to Raise or Lower the Setting Value by 1 (operation type B)

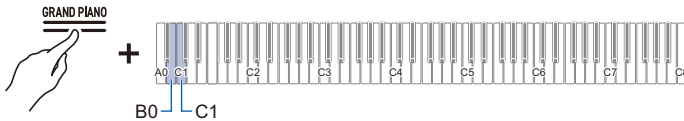

- Setting value: -2 to +2 octaves
- Default value: 0

Key	Setting
B0	Lowers the pitch of the Upper1 part by one octave (-)
C1	Raises the pitch of the Upper1 part by one octave (+)
B0 + C1	Resets the Upper1 part pitch to the default setting

### Shifting Upper2 Part by an Octave

While holding down the “GRAND PIANO” button, press the E♭7 or E7 key.

Using the +/- Keys to Raise or Lower the Setting Value by 1 (operation type B)

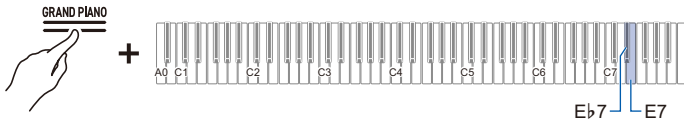

- Setting value: -2 to +2 octaves
- Default value: 0

Key	Setting
E♭7	Lowers the pitch of the Upper2 part by one octave (-)
E7	Raises the pitch of the Upper2 part by one octave (+)
E♭7 + E7	Resets the Upper2 part pitch to the default setting

## Changing the Scale Tuning (Temperament) of the Keyboard

By setting the scale of the keys, you can play music (Indian, Arabic, classical, etc.) that uses a scale other than the regular temperament (12 equal temperament). You can choose your favorite scale from 17 preset scales.

### Changing the Scale Tuning

**While holding down the “FUNCTION” button, press the F4 key (Scale Tuning Selection).**

Switching On/Off or Changing Setting Values Using a Single Key (operation type D)

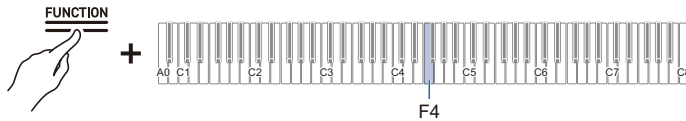

- A tone for default setting sounds when the set value reaches 0, and a separator tone sounds when the set value reaches 10.
- Default value: 0

Setting Value	Scale (Temperament) name
0	Equal Temperament
1	Pure Major Temperament
2	Pure Minor Temperament
3	Pythagorean Temperament
4	Kirnberger 3 Temperament
5	Werckmeister Temperament
6	Mean-Tone Temperament
7	Rast
8	Bayati
9	Hijaz
10	Saba
11	Dashti
12	Chahargah
13	Segah
14	Gurjari Todi
15	Chandrakauns
16	Charukeshi



## Setting the Scale Tuning Base Note

1. While holding down the “FUNCTION” button, press the F#4 key (Scale Tuning base note).

Putting in Standby Mode, and Executing on Next Key Press (operation type E)

- Do not release the “FUNCTION” button until the next operation is complete.

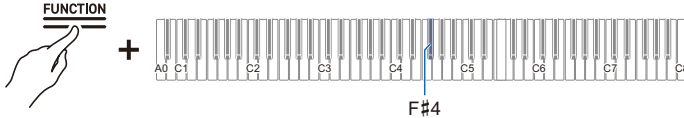

2. While holding down the “FUNCTION” button, specify the base note (C to B) you wish to set on the keyboard.

- Specify the base note by pressing one of the 88 keys.

## Switching Stretch Tuning On/Off

Generally, on a piano, the high notes are tuned higher and the low notes are tuned lower. This tuning is called “Stretch Tuning”.

While holding down the “FUNCTION” button, press the G4 key (Stretch Tuning).

Switching On/Off or Changing Setting Values Using a Single Key (operation type D)

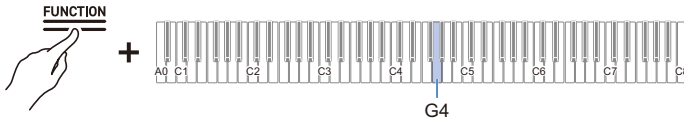

- Default value: On

Setting Value	Setting Details
Off	Turns off Stretch Tuning.
On	Turns on Stretch Tuning.

# Listening to Songs

## Types of Data that Can Be Played Back

This Digital Piano is equipped to play MIDI data (including built-in songs) and audio data.

### ■ MIDI Data

You can playback MIDI data stored in the Digital Piano's internal memory or USB flash drive.

For more information, see "[Playing MIDI Data](#)".

### ■ Audio Data

You can playback audio data stored on USB flash drives.

For more information, see "[Playing Audio Data \(WAV, MP3\)](#)".



- Depending on the type of data you want to playback, you need to switch the [Recorder] setting between <MIDI Recorder> and <Audio Recorder>.

## Playing MIDI Data

### ■ Music Library

Use the Music Library to listen to and practice famous piano pieces.

### Built-in Songs

These are 60 built-in songs (No.1 to 60 in the Music Library).

See "[Music Library List](#)" for song listings.

### User Songs

These are 10 songs (No.61 to 70 in the Music Library) saved to the Digital Piano's internal memory from an external source. Saving User Songs is executed using a smart device or via a USB flash drive connected to the Digital Piano.

For details, see "[Using the Dedicated App](#)" and "[Loading USB Flash Drive Files into the Digital Piano](#)".

### ■ MIDI Recorder Songs

These song are recorded with this Digital Piano's MIDI Recorder.

For more information, see "[Recording a Performance with the MIDI Recorder](#)".

### ■ USB Flash Drive Songs

A standard MIDI file (SMF format 0/1) or CASIO MIDI file (CMF format) song stored on a USB flash drive. You can easily play these back without loading them into the unit.

For saving MIDI data that can be played on this unit to a USB flash drive, see "[Copying MIDI Song Data to a USB Flash Drive Using a Computer](#)".

## Switching to MIDI Recorder

The default setting for [Recorder] on this Digital Piano is <MIDI Recorder>.

**While holding down the “FUNCTION” button, press the B3 key (MIDI Recorder).**

Selecting a Setting Value Directly (operation type A)

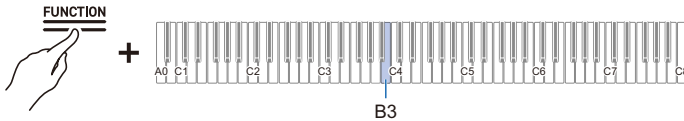

## Selecting Songs for Playback from the Music Library

Operate with <MIDI Recorder>.

Switching to MIDI Recorder

**1. Hold down the “▶/■” button and use the corresponding key to select a song. Once you have made your selection, release the “▶/■” button.**

- See “[Music Library List](#)” for song listings.

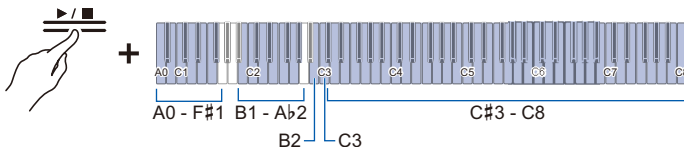

- Select a song assigned to a key (Built-in Songs: C#3 to C8 keys, User Songs: B1 to Ab2 keys)  
[Selecting a Setting Value Directly \(operation type A\)](#)
- Specify song numbers (Built-in Songs: 1 to 60, User Songs: 61 to 70) using the A0 to F#1 keys  
[Inputting Setting Values Using the Keys 0 to 9 \(operation type C\)](#)
- Use keys B2/C3 (Song Select – / Song Select +) to specify previous/next song (Built-in Songs, User Songs, MIDI Recorder Songs)  
[Using the +/- Keys to Raise or Lower the Setting Value by 1 \(operation type B\)](#)

**2. To start playback, touch the “▶/■” button.**

- To stop playback in the middle of a song, touch the “▶/■” button again.
- The beat indicator lights up in time with the beat of the song (left side for the first beat, right side for the remaining beats).
- Playback ends when the end of the song is reached.

### NOTE

- If a song selection is made, the appropriate settings for the selected song is automatically implemented. Also, the playback settings return to default.

## Selecting a MIDI Recorder Song for Playback

Operate with <MIDI Recorder>.

Switching to MIDI Recorder

1. While holding down the “▶/■” button, press the A2 key (MIDI Recorder Song).  
Selecting a Setting Value Directly (operation type A)

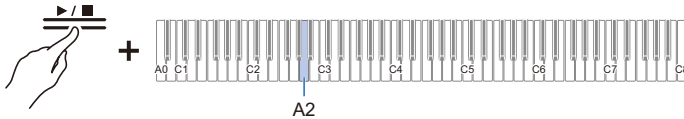

2. To start playing a song, touch the “▶/■” button.
  - To stop playback in the middle of a song, touch the “▶/■” button again.
  - Playback ends when the end of the song is reached.

## Selecting a USB Flash Drive Song for Playback

Attach the USB flash drive containing the songs to the USB Type A port on the Digital Piano.

For information on using USB flash drives, see “[Inserting/Removing a USB Flash Drive from the Digital Piano](#)”.

Operate with <MIDI Recorder>.

Switching to MIDI Recorder

1. While holding down the “▶/■” button, press the B $\flat$ 2 key (USB Flash Drive Song).  
Switching On/Off or Changing Setting Values Using a Single Key (operation type D)

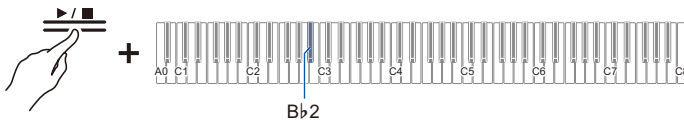

- Default value: Off

Setting Value	Setting Details
Off	Songs stored in the Digital Piano (Music Library songs, MIDI Recorder Song) are eligible for song selection
On	Songs stored on a USB flash drive (USB Flash Drive Songs) are eligible for song selection

- 2. Hold down the “▶/■” button and use the corresponding key to select a song. After selecting a song, press the “▶/■” button.**

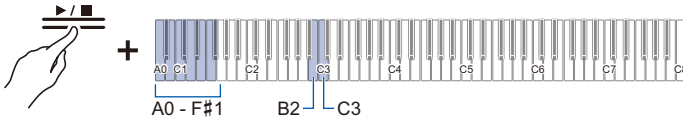

- Specify song numbers 0 to 99 using the A0 to F#1 keys (numbers 0 to 99 are automatically assigned to each file in ascending order of the file name).

[Inputting Setting Values Using the Keys 0 to 9 \(operation type C\)](#)

- Use keys B2/C3 (Song Select – / Song Select +) to specify previous/next song number

[Using the +/- Keys to Raise or Lower the Setting Value by 1 \(operation type B\)](#)

- 3. To start playback, touch the “▶/■” button.**

- To stop playback in the middle of a song, touch the “▶/■” button again.
- The beat indicator lights up in time with the beat of the song (left side for the first beat, right side for the remaining beats).
- Playback ends when the end of the song is reached.

#### **NOTE**

- If the file of the specified song number does not exist, a tone will sound for invalid.

## Changing the Tempo

Select the song to be played before changing the setting.

### 1. While holding down the “METRONOME” button, press the corresponding key.

- Sets the tempo in the range of 20 to 255 (beats per minute).

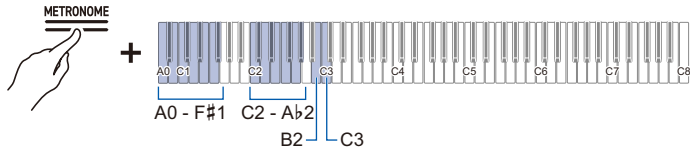

Entering Tempo as a Number

Raising or Lowering the Tempo Value by 1

Setting the Tempo from a Tempo Marking

### 2. To start playback, touch the “▶/■” button.

#### NOTE

- The tempo setting can be changed even during playback.
- In some songs, the tempo changes in the middle of the song for expression within the performance.

## Selecting a Playback Part

You can mute the right-hand or left-hand part of a song and practice playing it yourself.

- Select the song to be played before changing the setting.
- Set the tempo as needed.

For more information, see “[Changing the Tempo](#)”.

### 1. While holding down the “▶/■” button, press the B $\flat$ 1 key (Song Playback Part selection (LR/L/R)).

Switching On/Off or Changing Setting Values Using a Single Key (operation type D)

- The “L” and “R” track indicators light up respectively.

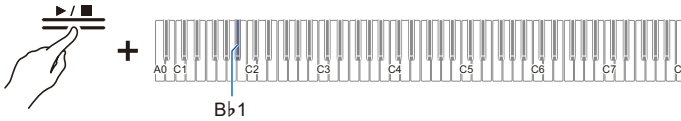

Track Indicator	Setting Details
Only L lights up	Plays the left-hand part and mutes the right-hand part.
Only R lights up	Plays the right-hand part and mutes the left-hand part.
Both L & R light up	Both left and right parts are played back.

### 2. To start playback, touch the “▶/■” button.

#### NOTE

- When playing a standard MIDI file (SMF format), ch3 will be the left-hand part and ch4 will be the right-hand part.

## Playing Audio Data (WAV, MP3)

### Data that Can be Played Back

Audio data in the AUDIOREC folder stored on a USB flash drive can be played back.

- WAV files (linear PCM, 16 bit, 44.1 kHz, stereo, extension: .WAV), file name "TAKE\*\*.WAV" (\*\* is 01-99)
- MP3 files (MPEG-1 Audio Layer3, 44.1 kHz/48 kHz, bit rate 32-320 kbps/variable bit rate (VBR) supported, mono/stereo, extension: .MP3), file name "TAKE\*\*.MP3" (\*\* is 01-99)

#### NOTE

- For saving audio data that can be played on this Digital Piano to a USB flash drive, see "[Copying Audio Data \(WAV, MP3\) to a USB Flash Drive Using a Computer](#)".

### Switching to Audio Recorder

Attach the USB flash drive containing the songs to the USB Type A port on the Digital Piano.

For information on using USB flash drives, see "[Inserting/Removing a USB Flash Drive from the Digital Piano](#)".

**While holding down the "FUNCTION" button, press the C4 key (Audio Recorder).**

[Selecting a Setting Value Directly \(operation type A\)](#)

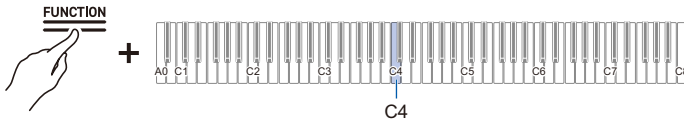



## Selecting a Song for Playback

Operate with <Audio Recorder>.

### Switching to Audio Recorder

1. Hold down the “▶/■” button and use the corresponding key to select a song. After selecting a song, release the “▶/■” button.

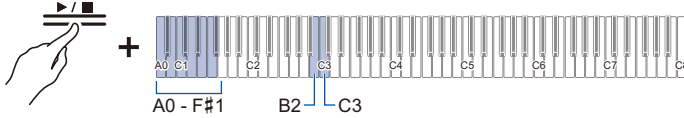

- Specify the TAKE\*\*.WAV or TAKE\*\*.MP3 (where \*\* = 01-99) file using the A0 to F#1 keys  
[Inputting Setting Values Using the Keys 0 to 9 \(operation type C\)](#)
  - Use keys B2/C3 (Song Select -/Song Select +) to specify previous/next song number  
[Using the +/- Keys to Raise or Lower the Setting Value by 1 \(operation type B\)](#)
2. To start playback, touch the “▶/■” button. To stop playback in the middle of a song, touch the “▶/■” button again.
    - Playback ends when the end of the song is reached.

### NOTE

- If the file of the specified song number does not exist, a tone will sound for invalid.
- When the WAV file name “TAKE\*\*.WAV” (\*\* is 01-99) and the MP3 file name “TAKE\*\*.MP3” (\*\* is 01-99) are the same, the WAV file will play.

# Recording a Performance

## MIDI Recorder and Audio Recorder Features

The Digital Piano has two recording functions: a MIDI Recorder and an Audio Recorder. Depending on the type of data you want to record or play back, you will need to switch the [Recorder] setting between <MIDI Recorder> and <Audio Recorder>.

### Recording Features

#### ■ MIDI Recorder

Performances are converted to MIDI data\* and recorded to two tracks (data domain where performances are recorded) in the internal memory.

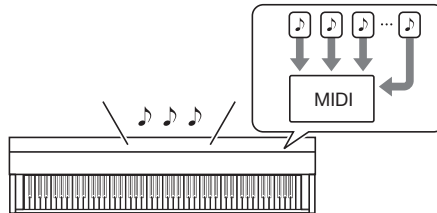

- Keyboard performance information (keys touched and released, touch strength, etc.) is recorded as MIDI data.
- MIDI data has the benefit of being extremely small in size compared to audio data, and it can be edited at a later date, e.g., on a computer.
- One song can be recorded. When a new recording is made, the previous recording is erased.
- The maximum number of notes that can be recorded in one song is approximately 10,000 notes as a total for both tracks.

\* MIDI

MIDI is an abbreviation for Musical Instrument Digital Interface. It is a unified standard that allows performance information (keys pressed and released, touch strength, etc.) to be exchanged between electronic musical instruments or between electronic musical instruments and computer equipment, regardless of manufacturer. The performance information exchanged is called MIDI data.

#### You can also:

**Record to the right-hand part track while playing the left-hand part track**

Left-hand part track

Keyboard performance

While playing back

Right-hand part track

Keyboard performance



## ■ Audio Recorder

Convert your performance into audio data\* and record it to a USB Flash Drive.

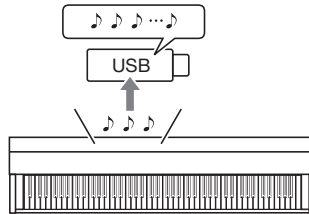

- The sound itself is recorded as audio data, similar to recording on a portable music player or tape recorder.
- Audio data files are extremely large in size compared to MIDI data. However, they have the advantage of being easy to listen to on a computer or portable music player.
- Up to 25 minutes and up to 99 files can be recorded on a USB flash drive.

### \* Audio Data

Audio data recorded with this Digital Piano is saved in WAV file format (linear PCM, 16 bit, 44.1 kHz, stereo).

### You can also:

**Record a performance while playing back a song recorded using the MIDI Recorder**



### NOTE

- For information about data file formats that are supported by this Digital Piano, see “[Types of Data that Can be Handled by this Digital Piano](#)”.
- Data recorded on the Digital Piano can be saved to a USB flash drive. See “[Saving MIDI Recorder Songs to a USB Flash Drive](#)”.

## Playback Features

### ■ MIDI Recorder

Play the left-hand part track and the right-hand part track (both or either).

- The MIDI Recorder automatically plays the internal sound source of this Digital Piano according to the performance information recorded as MIDI data.

#### You can also:

**Play the keyboard along with playback of the left-hand part track and the right-hand part track**

Left-hand part track

While playing back

Right-hand part track

While playing back

Keyboard performance

### Change the Tempo of a Recording

You can, for example, record at a slower tempo and play back at a faster tempo.

- The tempo set for the left-hand part track is applied to the right-hand part track.

### ■ Audio Recorder

Plays audio data from a USB flash drive.

- The Audio Recorder plays back the actual sound waveform, which is recorded as audio data.

#### You can also:

**Perform on the keyboard while playing audio data**

Play back songs from a USB flash drive



Keyboard Performance



#### NOTE

- For information about data file formats that are supported by this Digital Piano, see "[Types of Data that Can be Handled by this Digital Piano](#)".

## Recording a Performance with the MIDI Recorder

Records keyboard performances and pedal usage as MIDI data.

### IMPORTANT!

- Be aware that we will not be responsible for any damages, lost profits, or any claims from third parties arising from the deletion of recorded content due to malfunction or repair of this Digital Piano.

### Main Content Recorded by the MIDI Recorder

When recording with the MIDI Recorder, the following operations and settings are recorded to the Digital Piano's internal memory.

- Keyboard and pedal play
- Tone
- Tempo\*
- Beat\*
- Keyboard volume\*
- Layer settings (left-hand part track only)
- Split settings (left-hand part track only)
- Duet (left-hand part track only)
- Sound Mode (Hall Simulator/Reverb Type, Hall Simulator/Reverb depth for built-in sound source), Chorus, Brilliance\*
- Acoustic Simulator settings\*
- Scale Tuning\*
- Stretch Tuning\*

\* Left-hand part track only. However, the setting is also applied to the right-hand part track during playback.

### Preparing to Use the MIDI Recorder

Switch the [Recorder] setting to <MIDI Recorder>.

The default setting for [Recorder] on this Digital Piano is <MIDI Recorder>.

**While holding down the “FUNCTION” button, press the B3 key (MIDI Recorder).**

[Selecting a Setting Value Directly \(operation type A\)](#)

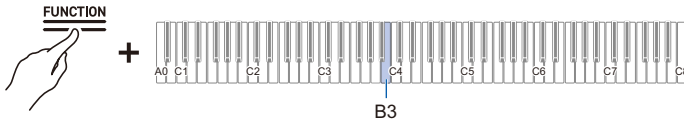

## Recording

### ■ Easy use of MIDI Recorder

1. **Touch the “●(REC)” button (lit white).**
  - The “●(REC)” button will start to blink red to indicate that recording is on standby.
2. **When you start to play, recording will begin automatically.**
  - The “●(REC)” button stops blinking red and changes to lit to indicate that recording is in progress.
3. **To end recording, touch the “●(REC)” button.**
  - The “●(REC)” button will return to a white light.
4. **To play the current recording, touch the “▶/■” button.**
  - To stop playback, touch the “▶/■” button again.

### ■ Recording to the Left-Hand Part Track

Switch [Recorder] to <MIDI Recorder> for operation.

[Preparing to Use the MIDI Recorder](#)

1. **Set tones, effects, tempo, etc. for recording as necessary.**
  - For setting beat and tempo, see [“Setting the Beat”](#) and [“Setting a Tempo”](#).
  - For track-by-track recording details, see [“Main Content Recorded by the MIDI Recorder”](#).
2. **Touch the “●(REC)” button (lit white).**
  - Recording goes to standby, and the “●(REC)” button blinks red.
  - The “L” in the Track Indicator flashes.
  - To stop the recording, touch the “●(REC)” button again.



3. **To sound the metronome while recording, touch the “METRONOME” button.**

#### 4. Recording will begin when you start playing.

- You can also start recording by holding down the “●(REC)” button and touching the “▶/■” button.
- The “●(REC)” button switches from a blink to a lit state, and the “▶/■” button goes off.
- If you want to redo your recording, see “[Starting over from the beginning during a recording](#)”.

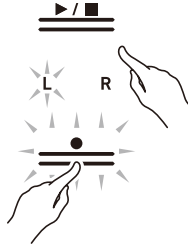

#### 5. To end recording, touch the “●(REC)” button.

- The “●(REC)” button will light up white again and the “▶/■” button will light up.
- To play back the recording immediately, touch the “▶/■” button.

#### Starting over from the beginning during a recording

If you want to redo the recording due to a performance error or other reason, hold down the “●(REC)” button until it flashes during recording. The recorded data is discarded and the process returns to a record standby state.

## ■ Overdub Recording (record to the right-hand part track to layer over the recording of the left-hand part track)

Use “[Recording to the Left-Hand Part Track](#)” to enter the record standby state before proceeding.

### 1. Touch and hold the “●(REC)” button until the “R” in the track indicator flashes.

- The right-hand part track will be recorded.
- The “L” in the track indicator switches from a blink to lit.



### 2. If you do not want the left-hand part track to play during recording, hold down the “▶/■” button and press the B♭1 key (Song Playback Part selection).

[Switching On/Off or Changing Setting Values Using a Single Key \(operation type D\)](#)

- The “L” in the track indicator goes off.
- Each time B♭1 key is pressed, the “L” in the track indicator switches between lit (Playback) and unlit (No Playback).

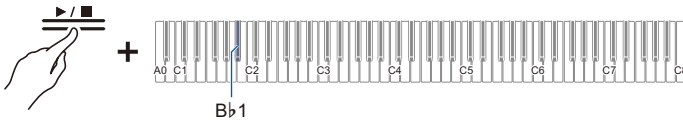

### 3. After this, operate from step 4, “[Recording to the Left-Hand Part Track](#)”.

#### NOTE

- Some settings recorded for the left hand part track, including beat and tempo, are also applied to the right hand part track recording.



## Erasing the Recording of a Track

---

Operate with <MIDI Recorder>.

### Preparing to Use the MIDI Recorder

- 1. Touch the “●(REC)” button (lit white).**
  - Recording goes into standby and the “●(REC)” button blinks red.
  - The “L” in the track indicator will blink, and the left-hand part track will be erased.



- 2. To erase the right hand-part track, press and hold the “●(REC)” button until the “R” in the track indicator blinks.**
- 3. While holding down the “●(REC)” button, touch the “▶/■” button.**
  - The “●(REC)” button switches from a blink to lit.
- 4. Hold down the “●(REC)” button until it blinks.**
  - The recording of the specified track will be erased.
- 5. Touch the “●(REC)” button to exit record standby.**

## Recording a Performance with the Audio Recorder

Records keyboard performances and pedal usage as audio data. Recordings are saved in WAV file format (linear PCM, 16 bit, 44.1 kHz, stereo) to a USB flash drive connected to the USB Type A port.

### IMPORTANT!

- Do not remove the USB flash drive during recording or playback on the Audio Recorder. Doing so can corrupt the data on the USB flash drive and damage the USB Type A port.
- For more information on using USB flash drives, see [“Using a USB Flash Drive”](#).
- For supported USB flash drive formats see [“Supported USB Flash Drives”](#).

## Preparing to Use the Audio Recorder

Connect a USB flash drive to the USB Type A port of the Digital Piano.

For information on using USB flash drives, see [“Inserting/Removing a USB Flash Drive from the Digital Piano”](#).

Switch the [Recorder] setting to <Audio Recorder>.

**While holding down the “FUNCTION” button, press the C4 key (Audio Recorder).**

[Selecting a Setting Value Directly \(operation type A\)](#)

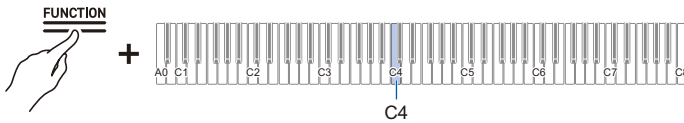

## Recording Audio Recorder Songs (WAV) Directly to a USB Flash Drive

Operate with <Audio Recorder>.

### Preparing to Use the Audio Recorder

#### 1. Touch the “●(REC)” button (lit white).

- Recording goes into standby and the “●(REC)” button blinks red.
- To stop the recording, touch the “●(REC)” button again.



#### 2. Recording will begin when you start playing.

- You can also start recording by holding down the “●(REC)” button and touching the “▶/■” button.
- The “●(REC)” button switches from a blink to lit, and the “▶/■” button goes off.

#### 3. To end recording, touch the “●(REC)” button.

- The “●(REC)” button will light up white again and the “▶/■” button will light up.

#### 4. To play the recording, touch the “▶/■” button.

#### NOTE

- The maximum recording time available is approximately 25 minutes, after which recording will automatically end. The “●(REC)” button will start blinking when there is limited time left available for recording.
- Recordings are saved as WAV files on a USB flash drive. The files are named and saved “TAKE01.WAV” to “TAKE99.WAV” in the order in which they were recorded.
- Files recorded by the Audio Recorder are saved with a filename that follows the last MP3 or WAV audio file.

#### ■ When you want to start over from the beginning during a recording

If you want to redo the recording due to a performance error or other reason, hold down the “●(REC)” button until it flashes during recording. The recorded data is discarded and the process returns to a record standby state.

## Recording to the Audio Recorder while Playing Back Data Recorded to the MIDI Recorder

1. While holding down the “FUNCTION” button, press the C#4 key (Audio Rec with MIDI playback).

Selecting a Setting Value Directly (operation type A)

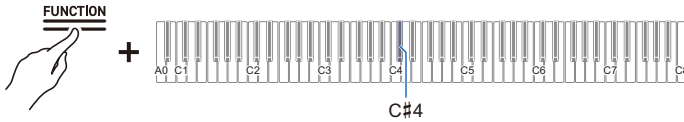

2. Attach the USB flash drive to the USB Type A port.

3. Touch the “●(REC)” button (lit white).

- Recording goes into standby and the “●(REC)” button blinks red.
- The track indicator of the part being recorded with the MIDI Recorder will light up.



4. To set the playback part, hold down the “▶/■” button and press the Bb1 key (Song Playback Part selection).

Switching On/Off or Changing Setting Values Using a Single Key (operation type D)

- The “L” and “R” track indicators light up respectively.

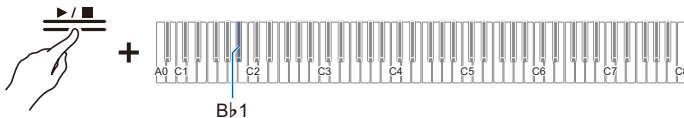

Track Indicator	Setting Details
Only L lights up	Plays the left-hand part and mutes the right-hand part.
Only R lights up	Plays the right-hand part and mutes the left-hand part.
Both L & R light up	Both left and right parts are played back.

## 5. Recording will begin when you start playing.

- The MIDI Recorder Song will play as recording begins.
- You can also start recording by holding down the “●(REC)” button and touching the “▶/■” button.
- The beat indicator lights up in time with the beat.
- If you want to redo your recording, see “[When you want to start over from the beginning during a recording](#)”.

## 6. To end recording, touch the “●(REC)” button.

- The “●(REC)” button will light up white again and the “▶/■” button will light up.
- To play the recording immediately, touch the “▶/■” button.

### NOTE

- The maximum recording time available is approximately 25 minutes, after which recording will automatically end. The “●(REC)” button will start blinking when there is limited time available for recording.
- Recordings are saved as WAV files on a USB flash drive. The files are named and saved “TAKE01.WAV” to “TAKE99.WAV” in the order in which they were recorded.
- Files recorded by the Audio Recorder are saved with a filename that follows the last MP3 or WAV audio file.

## Deleting a Recorded File

Operate with <Audio Recorder>.

[Preparing to Use the Audio Recorder](#)

1. Hold down the “▶/■” button and select the file to be deleted with the corresponding key.

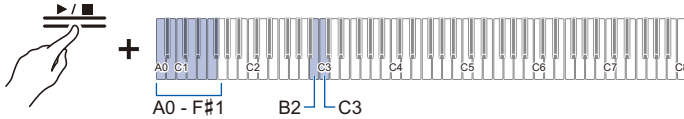

- Use the A0 to F#1 keys to specify the TAKE\*\* .WAV (\*\* is 01-99) number  
[Inputting Setting Values Using the Keys 0 to 9 \(operation type C\)](#)
- Use keys B2/C3 (Song Select –/Song Select +) to specify previous/next song number  
[Using the +/- Keys to Raise or Lower the Setting Value by 1 \(operation type B\)](#)

2. While holding down the “FUNCTION” button, press the B1 key (Delete SMF/MRF/Audio).

[Putting in Standby Mode, and Executing on Next Key Press \(operation type E\)](#)

- Do not release the “FUNCTION” button until the next operation is complete.

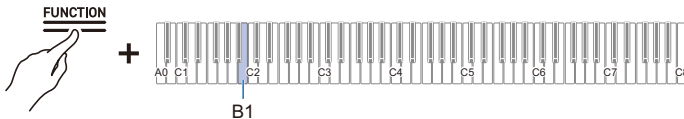

3. While holding down the “FUNCTION” button, press the C1 key (Execute).

- The file is deleted.

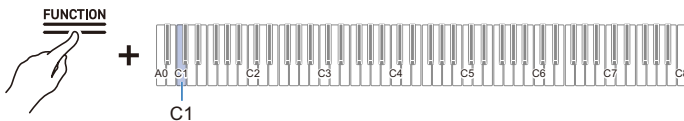

### NOTE

- The number specified for deletion applies to both WAV and MP3 files. If a WAV file and MP3 file share the same number, they will both be deleted.

# Using a USB Flash Drive

## Using a Commercially Available USB Flash Drive – What You Can Do

You can do the following using a commercially available USB flash drive.

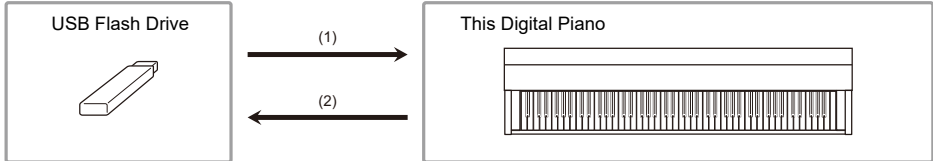

### (1) Using a file on a USB flash drive with this Digital Piano

- Direct playback of audio files from a USB flash drive  
For more information, see [“Playing Audio Data \(WAV, MP3\)”](#).
- Direct playback of MIDI files on a USB flash drive  
For more information, see [“Playing MIDI Data”](#).
- Load compatible files from a USB flash drive into the Digital Piano  
For more information, see [“Loading USB Flash Drive Files into the Digital Piano”](#).
- Erase USB Flash Drive Files  
See [“Deleting USB Flash Drive Files”](#).

### (2) Save data from the Digital Piano to a USB flash drive

- Record Audio Recorder songs (WAV) directly to a USB flash drive  
For more information, see [“Recording Audio Recorder Songs \(WAV\) Directly to a USB Flash Drive”](#).
- Save MIDI Recorder Songs to a USB Flash Drive  
For more information, see [“Saving MIDI Recorder Songs to a USB Flash Drive”](#).

## Preparing a USB Flash Drive

### Supported USB Flash Drives

Use FAT32 or exFAT formatted USB flash drives.

- For USB flash drives with large capacities, mounting and formatting may take some time.
- Depending on the performance and characteristics of the USB flash drive, it may not be possible to correctly perform recording/playback.

### IMPORTANT!

- It may not be possible to use USB flash drives that are recognized as multiple drives on a computer.
- USB flash drives that are recognized as CD-ROMs on a computer cannot be used.
- USB flash drives with special functions, such as anti-virus or security features, cannot be used.

### Types of Data that Can be Handled by this Digital Piano

#### ■ Audio data

##### WAV format

A standard audio file format used primarily in Windows. This Digital Piano is compatible with Linear PCM, 16 bit, 44.1 kHz, stereo WAV files (extension: .WAV).

##### MP3 format

A common audio file format widely used for music distribution. This Digital Piano supports 44.1/48 kHz, 32–320 kbps bit rate, and variable bit rate (VBR) compatible MP3 files (extension: .MP3).

#### ■ MIDI data

##### MRF format (CASIO's original file format)

MIDI data recorded by the Digital Piano's MIDI Recorder (extension: .MRF).

##### CMF format (CASIO's original file format)

CASIO's own MIDI data to which performance information is added (extension: .CMF).

##### SMF (Standard MIDI File) format, Format 0/1:

Standard MIDI file format compatible with MIDI equipment from other manufacturers (extension: .MID).



Data Type		Extension	Save (Internal memory → USB flash drive)	Load (USB flash drive → internal memory)	Direct recording to USB flash drive	Playback directly from USB flash drive
Audio	Audio Recorder Song File	.WAV	–	–	✓	✓
	General Audio File	.WAV	–		–	
		.MP3		–		
MIDI	MIDI Recorder Song File	.MRF	✓*1	✓	–	–
	CASIO MIDI File	.CMF	–	✓*2	–	✓
	Standard MIDI file (SMF format)	.MID				

\*1 Can also be converted to a standard MIDI file (SMF format 0, extension: .MID) and saved.

- When saving in MRF format

Not only performance information, but also settings for functions specific to this Digital Piano (such as Acoustic Simulator settings) are saved. When a file saved in this format is played back on the Digital Piano, the original performance is reproduced. However, MRF files cannot be used with other instruments.

- When saving in SMF format

Performance information is saved, but the settings for the unit-specific functions are not. Therefore, even if a file saved in this format is played back on this Digital Piano, the unit-specific settings of the unit's functions are not restored to their original settings. However, files saved in this format can be used with other SMF-compatible instruments. (It is not possible to reproduce the same performance from this unit on other instruments.)

\*2 Loaded as a User Song (song numbers 61-70). See "[Loading USB Flash Drive Files into the Digital Piano](#)".

### Copyrights

You are allowed to use recordings for your own personal use. Any reproduction of an audio or music format file, without the permission of its copyright holder, is strictly prohibited under copyright laws and international treaties. Also, making such files available on the Internet or distributing them to third parties, regardless of whether such activities are conducted with or without compensation, is strictly prohibited under copyright laws and international treaties. CASIO COMPUTER CO., LTD. shall not be held in any way liable for any use of this Digital Piano that is illegal under copyright laws.

## Inserting/Removing a USB Flash Drive from the Digital Piano

- Follow the precautions in the instructions that are supplied with the USB flash drive.
- Avoid storing or using the product in the places outlined below. Data on the USB flash drive may be corrupted.
  - Locations with high temperature, humidity, or corrosive conditions
  - Locations prone to strong static electricity or electrical noise
- Do not operate the Digital Piano or remove the USB flash drive while data is being saved or loaded. Doing so can corrupt the data on the USB flash drive and damage the USB Type A port.
- Never insert devices other than those specified in this manual into the USB Type A port. Doing so may cause malfunction.
- When operating a USB flash drive for the first time after it is inserted into the Digital Piano, or when operating a USB flash drive for the first time after turning on the power, the Digital Piano may become temporarily inoperable as the system prepares to exchange data with the USB flash drive (mounting).
- Mounting is executed each time a USB flash drive is inserted into the Digital Piano.
- During mounting, the indicators above the “SOUND MODE” and “▶/■” buttons will light up sequentially. Do not operate the Digital Piano while it is mounting.
- It may take tens of seconds to several minutes for the monitoring system to complete mounting and become operational.

### ■ Insertion

#### Insert the USB flash drive into the USB Type A port of the Digital Piano.

- Make sure to fully insert. Do not force insertion.

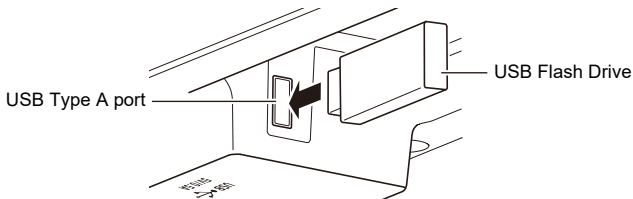

- The Digital Piano may malfunction if static electricity is transferred to the USB Type A port from your hand or a USB flash drive. If this happens, turn the Digital Piano off and then back on again.

### ■ Removal

#### Make sure that no data is being exchanged between the Digital Piano and the USB flash drive, before unplugging and removing the USB flash drive.

- After prolonged use, the USB flash drive, which was removed, may be warm, but this is not a malfunction.

## Formatting a USB Flash Drive

When a USB flash drive is formatted in this Digital Piano, a folder named “CASIO” is created in the root directory. This folder is always used when exchanging data between the Digital Piano and the USB flash drive.

Diagram of the USB flash drive folder structure:

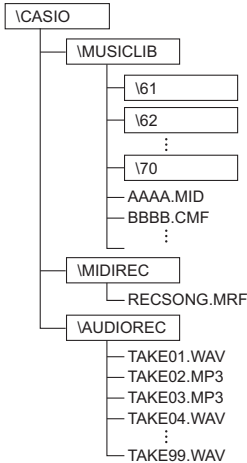

### IMPORTANT!

- **Be sure to format the USB Flash Drive on the Digital Piano first.**
- **Formatting a USB flash drive will delete all data on the USB flash drive. Before formatting, make sure that no important data is stored on the USB flash drive.**
- **The format operation performed by this Digital Piano is a “quick format”. To completely delete data, perform a normal format on a computer or other device before formatting on this Digital Piano.**
- **The exFAT format may limit the number of files that can be read if some files have long names.**

1. Insert the USB flash drive to be formatted into the USB Type A port on the Digital Piano.
2. Press and hold the “FUNCTION” button.

Putting in Standby Mode, and Executing on Next Key Press (operation type E)

- Do not release the “FUNCTION” button until step 4.

3. Press the C2 key (Format).

- The right side of the beat indicator blinks and the Digital Piano enters the format standby state.

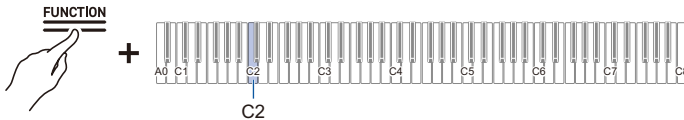

4. Press the C1 key (Execute).

- Formatting will take place. During formatting, the indicators above the “SOUND MODE” and “▶/■” buttons will light up sequentially.

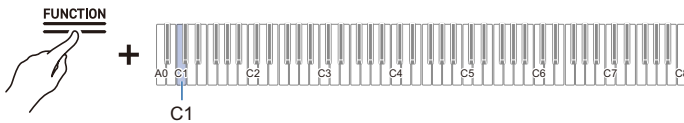

5. Once formatting begins, release the “FUNCTION” button.

- When formatting is complete, the indicator returns to its original state.

## Operations with a USB Flash Drive

### Saving MIDI Recorder Songs to a USB Flash Drive

- 1. Insert the USB flash drive into the USB Type A port of the Digital Piano.**
- 2. To save in SMF format (.MID), do the following:**
  - (1) Switch the Digital Piano to <MIDI Recorder>.
    - [Switching to MIDI Recorder](#)
  - (2) Select the User Song number that corresponds to the save destination folder (61-70).
    - While holding down the “▶/■” button, press one of the A0 to F#1 keys.
    - [Inputting Setting Values Using the Keys 0 to 9 \(operation type C\)](#)
- 3. Press and hold the “FUNCTION” button.**
  - [Putting in Standby Mode, and Executing on Next Key Press \(operation type E\)](#)
  - Do not release the “FUNCTION” button until step 5.
- 4. Press either the A1 or B♭1 key.**
  - The Hall Simulator/Reverb Indicator blinks and enters save standby.

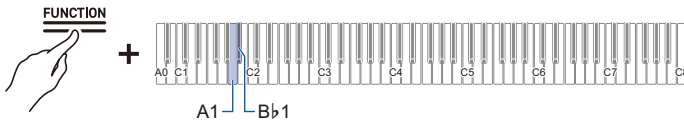

Key	Setting	Storage Location
A1	Saves in SMF format (.MID)	Specified folder in MUSICLIB folder (61-70)
B♭1	Saves in CASIO's proprietary format (.MRF)	MIDIREC Folder

## 5. Press key C1 (Execute).

- Save is executed. During processing, the indicators above the “SOUND MODE” and “▶/■” buttons light up sequentially.

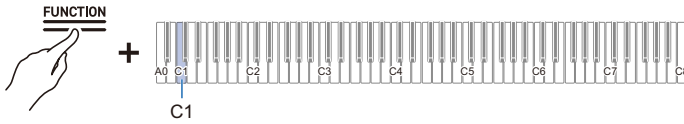

## 6. Once saving begins, release the “FUNCTION” button.

- When saving is complete, the indicator returns to its original state.

## Loading USB Flash Drive Files into the Digital Piano

### 1. Copy the data to be loaded into the Digital Piano to the respective folders on the USB flash drive.

- Only one song from each folder can be loaded. When there are multiple files, the first file in the order of the file naming is loaded.

Data Type	Folder
User songs (CMF, MID)	61-70 in MUSICLIB folder
MIDI Recorder songs (MRF)	MIDIREC Folder

### 2. Insert the USB flash drive into the USB Type A port of the Digital Piano.

### 3. Switch the Digital Piano to <MIDI Recorder>.

[Switching to MIDI Recorder](#)

### 4. Select the User Song (song numbers 61-70) or MIDI Recorder Song that corresponds to the data to be loaded.

- To select a User Song, hold down the “▶/■” button and press one of the A0 to F#1 keys.

[Inputting Setting Values Using the Keys 0 to 9 \(operation type C\)](#)

- To select a MIDI Recorder song, hold down the “▶/■” button and press the A2 key.

[Selecting a Setting Value Directly \(operation type A\)](#)

## 5. Press and hold the “FUNCTION” button.

Putting in Standby Mode, and Executing on Next Key Press (operation type E)

- Do not release the “FUNCTION” button until step 7.

## 6. Press the **A<sub>b</sub>1** key (Load SMF/MRF).

- The surround indicator will blink and enter load standby mode.

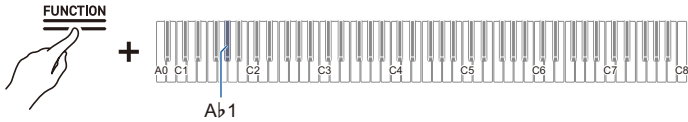

## 7. Press key **C1** (Execute).

- Loading is executed. During processing, the indicators above the “SOUND MODE” and “▶/■” buttons light up sequentially.

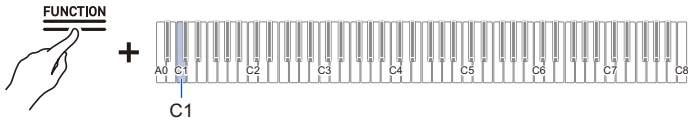

## 8. Once loading begins, release the “FUNCTION” button.

- When loading is complete, the indicator returns to its original state.

## Deleting USB Flash Drive Files

Deletes the following data from the USB flash drive

- Songs stored in folders 61 to 70 in the MUSICLIB folder
- RECSONG.MRF stored in the MIDIREC folder
- TAKE\*\*.WAV (\*\*=01 - 99) or TAKE\*\*.MP3 (\*\*=01 - 99) audio song data stored in the AUDIOREC folder

### 1. Insert the USB flash drive into the USB Type A port of the Digital Piano.

### 2. Select the data to be deleted.

- To delete a User Song or MIDI Recorder Song:

(1) Switch the Digital Piano to <MIDI Recorder>.

[Switching to MIDI Recorder](#)

(2) Select the User Song number or MIDI Recorder Song that corresponds to the data to be deleted.

To select a User Song, hold down the “▶/■” button and press one of the A0 to F#1 keys.

[Inputting Setting Values Using the Keys 0 to 9 \(operation type C\)](#)

To select a MIDI Recorder Song, hold down the “▶/■” button and press the A2 key.

[Selecting a Setting Value Directly \(operation type A\)](#)

- To delete audio data:

(1) Switch the Digital Piano to <Audio Recorder>.

[Switching to Audio Recorder](#)

(2) Specify the TAKE\*\*.WAV or TAKE\*\*.MP3 (\*\*=01 - 99) audio data to delete.

While holding down the “▶/■” button, press one of the A0 to F#1 keys.

[Inputting Setting Values Using the Keys 0 to 9 \(operation type C\)](#)

### 3. Press and hold the “FUNCTION” button.

[Putting in Standby Mode, and Executing on Next Key Press \(operation type E\)](#)

- Do not release the “FUNCTION” button until step 5.



#### 4. Press the B1 key (Delete SMF/MRF/Audio).

- The left side of the beat indicator blinks to indicate delete standby mode.

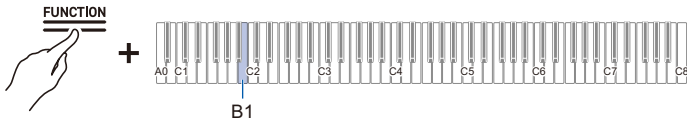

#### 5. Press key C1 (Execute).

- Deletion is executed. During processing, the indicators above the “SOUND MODE” and “▶/■” buttons light up sequentially.

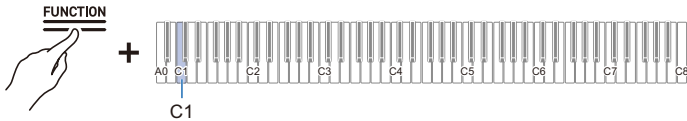

#### 6. Once deletion begins release the “FUNCTION” button.

- When the deletion is complete, the indicator returns to its original state.

#### NOTE

- If there are WAV and MP3 files with the same name, executing file deletion will delete both the WAV and the MP3 files.

## Copying MIDI Song Data to a USB Flash Drive Using a Computer

You can save files in the following formats to the MUSICLIB folder in the CASIO folder created on a USB flash drive and play them on this Digital Piano.

- Standard MIDI file (SMF format 0/1) or CASIO MIDI file (CMF format)

- 1. Connect the USB flash drive to the computer.**
- 2. Create a CASIO folder in the root directory of the USB flash drive and create a folder named MUSICLIB in the CASIO folder.**
  - If you already have a MUSICLIB folder, this step is not necessary.
- 3. Copy the song data you want to play on the Digital Piano to the MUSICLIB folder on the USB flash drive.**
  - For song data playback, see [“Playing MIDI Data”](#).

## Copying Audio Data (WAV, MP3) to a USB Flash Drive Using a Computer

When you record with this Digital Piano's Audio Recorder, the recordings are stored in a WAV file format under the AUDIOREC folder in the CASIO folder on the USB flash drive from “TAKE01.WAV” to “TAKE99.WAV”, the number changing at the end of new file names each time a recording is made. Connect a USB flash drive to your computer, change audio data file names to “TAKE\*\* .WAV” (\*\* is 01 - 99) or MP3 file names to “TAKE\*\* .MP3” (\*\* is 01 - 99), and save in the AUDIOREC folder to play the files on this Digital Piano.

- WAV files (Linear PCM, 16 bit, 44.1 kHz, stereo, extension: .WAV)
- MP3 files (MPEG-1 Audio Layer 3, 44.1 kHz/48 kHz, bit rate 32 to 320 kbps/variable bit rate (VBR) compatible, mono/stereo, extension: .MP3)

For information on audio data playback, see [“Playing Audio Data \(WAV, MP3\)”](#).

# Connecting Wirelessly

## Connecting the Digital Piano to External Devices Wirelessly

The supplied Wireless MIDI & audio adaptor can be used to connect the Digital Piano to external devices wirelessly. This connection uses Bluetooth wireless technology, and the following two types of connections are possible:

- Bluetooth Low Energy MIDI Connectivity  
Sends and receives MIDI data between the Digital Piano and smart devices.
- Bluetooth audio connectivity  
Plays the sound being played back from an external device on this Digital Piano.

## Wireless (Bluetooth) Connectivity Settings

### Wireless Function On/Off

The [Wireless Function] of the Digital Piano is set to <On> by default. When necessary, such as when you want to stop the generation of radio waves, you can turn the [Wireless Function] <Off>.

1. Insert the Wireless MIDI & audio adaptor into the USB Type A port on the Digital Piano.
2. While holding down the “FUNCTION” button, press the D1 key (Wireless Function).

Switching On/Off or Changing Setting Values Using a Single Key (operation type D)

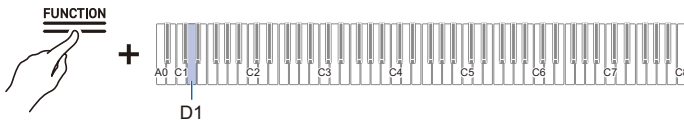

- Default value: On

Setting Value	Setting Details
Off	Turns off the Wireless Function.
On	Turns on the Wireless Function.

## Adjusting the Notification Tone Volume for Wireless Connection/ Disconnection

You can adjust the Notification Tone Volume that sounds when the wireless connection status changes.

### ■ Notification Tones

Notification Details	Notification Tone
Connected to Bluetooth audio-enabled device	A piano tone with an ascending melody plays.
Disconnected from a Bluetooth audio-enabled device	A piano tone with a descending melody plays.
Connected to a Bluetooth Low Energy MIDI-enabled device	A vibraphone tone with a ascending melody plays.
Disconnected from a Bluetooth Low Energy MIDI-enabled device	A vibraphone tone with a descending melody plays.

### ■ Adjusting the Notification Tone Volume

While holding down the “FUNCTION” button, press the E $\flat$ 1 or E1 key.

Using the +/- Keys to Raise or Lower the Setting Value by 1 (operation type B)

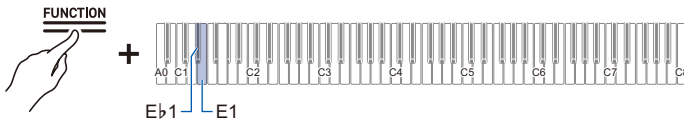

- Setting value: 0 (silence) to 10 (maximum volume)
- Default value: 5

Key	Setting
E $\flat$ 1	Lowers the volume of the connection notification tone by 1 (–)
E1	Raises the volume of the connection notification tone by 1 (+)
E $\flat$ 1 + E1	Resets the volume of the connection notification tone to its default setting

## Bluetooth Low Energy MIDI Connectivity

Bluetooth Low Energy MIDI connection between the Digital Piano and a smart device enables various operations using a dedicated app. To connect with Bluetooth Low Energy MIDI, you need to install the dedicated app on your smart device.

For more information about the dedicated app, see “[Downloading the App \(CASIO MUSIC SPACE\) for Smart Devices](#)”.

- 1. If the [Wireless Function] of the Digital Piano is <Off>, switch it to <On>.**
  - For more information, see “[Wireless Function On/Off](#)”.
- 2. Insert the Wireless MIDI & audio adaptor into the USB Type A port on the Digital Piano.**
- 3. Open the settings screen of the smart device and check the Bluetooth function is on.**
- 4. On the settings screen of the dedicated app installed on the smart device, select “WU-BT10 MIDI” and connect it to this Digital Piano.**
  - For details, see the dedicated app instruction manual.
  - Do not operate the Digital Piano while it is waiting to connect to a smart device.
  - When connected, the left side of the “ (Power)” button lights up blue.

### NOTE

- Each time the dedicated app is used with a Bluetooth Low Energy MIDI connection, the operation described in step 4 above is required.
- Connecting this Digital Piano to Bluetooth Low Energy MIDI and Bluetooth audio from an external device at the same time may result in unstable MIDI operation depending on the external device and OS version. If this happens, disconnect the Bluetooth audio connection using the external device.

## Bluetooth Audio Connectivity

Using the supplied Wireless MIDI & audio adaptor, you can pair the Digital Piano with a Bluetooth audio-enabled device (smart device) to play sound from an external device through the Digital Piano's speakers.

### ! IMPORTANT!

- When pairing, keep the volume of the Digital Piano and the external device turned down to a low level.
- If the sound of an external device played by the Digital Piano sounds distorted, turn down the volume of the external device.
- Due to the characteristics of Bluetooth, sound is delayed.

### Bluetooth Audio Pairing

1. Insert the Wireless MIDI & audio adaptor into the USB Type A port on the Digital Piano.

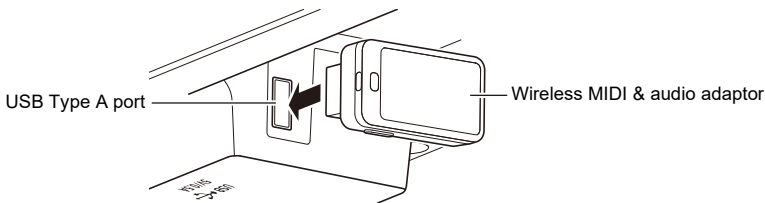

2. Open the settings screen of the external device and switch the Bluetooth function to on if it is off.
3. While holding down the “FUNCTION” button on the Digital Piano, press the C#1 key (Wireless Audio Pairing).

[Selecting a Setting Value Directly \(operation type A\)](#)

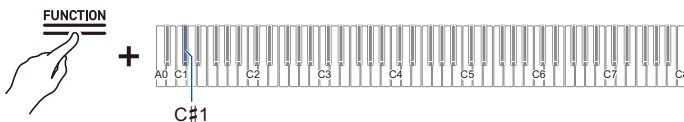

- The device enters pairing standby.
  - The right side of the “⏻ (Power)” button will flash blue to indicate that the device is standing by for pairing.
4. Select “WU-BT10 AUDIO” on the Bluetooth settings screen of the external device and pair it with this Digital Piano.
    - When connected, a notification tone will sound and the right side of the “⏻ (Power)” button will light up blue.

## ■ If the Bluetooth Audio Connection Does Not Work Properly

### 1. Clear pairing registration.

- For more information, see [“Clearing Pairing Registration”](#).

### 2. If pairing registration information from this Digital Piano remains on the external device, delete it.

- Delete “WU-BT10 AUDIO” from the Bluetooth settings screen of the external device. For how to do this, see the external device’s instruction manual.

### 3. Retry Bluetooth audio pairing.

- For more information, see [“Bluetooth Audio Pairing”](#).

#### NOTE

- The pairing information of the last external device connected via Bluetooth audio is registered in the Wireless MIDI & audio adaptor. From then on, a Bluetooth audio connection is automatically established without the need for Bluetooth audio pairing.

## Clearing Pairing Registration

Delete pairing registrations between the Digital Piano and external devices connected via Bluetooth audio.

### NOTE

- After executing the following operation, delete pairing registration information with this Digital Piano, even for external devices that were connected to this Digital Piano via Bluetooth audio. Delete "WU-BT10 AUDIO" from the Bluetooth settings screen of the external device. For how to do this, see the external device's instruction manual.

**1. Insert the Wireless MIDI & audio adaptor into the USB Type A port on the Digital Piano.**

**2. Press and hold the "FUNCTION" button.**

Putting in Standby Mode, and Executing on Next Key Press (operation type E)

- Do not release the "FUNCTION" button until step 4.

**3. Press the F1 key (Delete Connection History).**

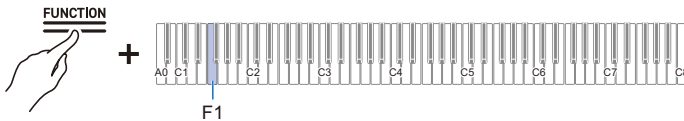

**4. Press the C1 key (Execute) to clear pairing registrations.**

**5. Release the "FUNCTION" button.**



## Adjusting Wireless Audio Playback Volume

While holding down the “FUNCTION” button, press the B2 or C3 key.

Using the +/- Keys to Raise or Lower the Setting Value by 1 (operation type B)

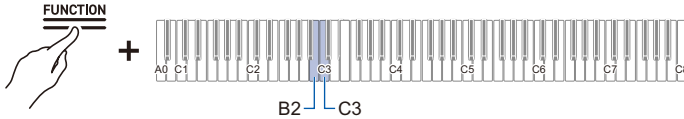

- Setting value: 0 (silence) to 42 (maximum volume)  
A separator tone sounds when the set value becomes a multiple of 10.
- Default value: 35

Key	Setting
B2	Lowers wireless audio playback volume by 1 (-)
C3	Raises wireless audio playback volume by 1 (+)
B2 + C3	Resets wireless audio playback volume to default setting

# Using the Dedicated App

## Downloading the App (CASIO MUSIC SPACE) for Smart Devices

When using the dedicated CASIO MUSIC SPACE app, you can enjoy numerous features linked to this Digital Piano.

### Main App Features

- Remote Controller
- Piano Roll
- Music Player

See the CASIO MUSIC SPACE instruction manual for details on each function and other features.

[https://web.casio.com/app/en/music\\_space/manual/](https://web.casio.com/app/en/music_space/manual/)

## 1. Installing CASIO MUSIC SPACE on Your Smart Device

- See “Downloads” at the following website.

AP-300

<https://support.casio.com/global/en/emi/manual/AP-300/>



AP-S200

<https://support.casio.com/global/en/emi/manual/AP-S200/>



## 2. Connecting this Digital Piano to a Smart Device

- There are two types of connections: wireless and cable. Available features vary depending on the connection method.
- Do not make Bluetooth Low Energy MIDI connections and USB MIDI connections at the same time.

Main App Features	Wireless Connection		Cable Connection
	Bluetooth Low Energy MIDI Connection* <sup>2</sup>	Bluetooth Audio Connection* <sup>3</sup>	USB MIDI Connection* <sup>4</sup>
Remote Controller	✓	–	✓
Piano Roll* <sup>1</sup>	✓	–	✓
Music Player	–	✓	–

CASIO MUSIC SPACE website

[https://web.casio.com/app/en/music\\_space/](https://web.casio.com/app/en/music_space/)

\*<sup>1</sup> User Songs can be transferred to this Digital Piano using this function.

\*<sup>2</sup> See [Bluetooth Low Energy MIDI Connectivity](#)

\*<sup>3</sup> See [Bluetooth Audio Connectivity](#)

\*<sup>4</sup> See [Connecting a Smart Device with USB MIDI](#)

# Using with an External Device with a Cable Connection

## Connecting to a Computer or Smart Device and Using MIDI

You can send and receive performance information (MIDI data) by connecting this Digital Piano to a computer or smart device. You can use music software on your computer or a smart device application to record your performance on this Digital Piano, or send data from your computer or smart device to this Digital Piano and play the sound.

### NOTE

- For detailed specifications and connection information on sending and receiving MIDI data with this Digital Piano, see "[Latest Support Information](#)".
- For MIDI-related settings, see "[Changing MIDI Settings](#)".

## Computer Operating Environment

The operating environment required to send and receive MIDI data is as follows: Always confirm the environment of your computer in advance.

- USB port
- Supported OS
  - Windows 10\*
  - Windows 11
  - macOS 10.15, 11, 12, 13, 14

\* Windows 10 (32-bit and 64-bit versions)

### NOTE

- For the latest information on supported OS, see "[Latest Support Information](#)".

## Connecting to a Computer

### **IMPORTANT!**

- Failure to connect using the correct procedure may result in the inability to send and receive data. Always follow the steps below to make a connection.
- After connecting, always turn on the Digital Piano before starting up music software on your computer.

1. Turn off the power to the Digital Piano and start up the computer.
  - Do not start up any music software on your computer.
2. Connect the computer and the Digital Piano using the USB Type B port of the Digital Piano with a commercially available USB cable.
  - Use a data transfer cable with the USB Type B (USB 1.1 or 2.0) connector.

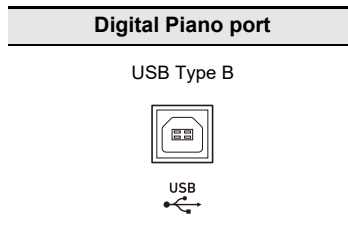

3. Turn on the Digital Piano's power.
  - When connecting for the first time, the driver required to send and receive data is automatically installed on the computer.
4. Start the music software (commercially available) on your computer.
5. In the settings of your computer's music software (commercially available), select MIDI Device.
  - The MIDI device name is "CASIO AP-300 USB" for AP-300, and "CASIO AP-S200 USB" for AP-S200.
  - See the manual of your music software for information on how to select a MIDI device.

### **NOTE**

- After one successful connection, the USB cable can be left connected and the computer or this Digital Piano can be turned on and off.

## Smart Device Operating Environment

---

You can connect to smart devices and use apps that use MIDI standards.

See “[Latest Support Information](#)” for confirmed compatible devices.

- We recommend using the devices listed in the “Tested devices (USB-MIDI connection)” section.
- Operation confirmation results do not guarantee operation on that device.
- Depending on your environment, you may not be able to connect correctly.
- Even if the device has been tested, it may not work properly due to device or OS version upgrades, etc.

## Connecting a Smart Device with USB MIDI

---

- Use a cable that supports data communication.
- Charging cables are not compatible.

- 1. Turn on the Digital Piano and the smart device.**
- 2. Connect the smart device to the USB Type B port of this Digital Piano using the connection cable.**
  - For connection cables, see “Cable Connection (USB Cable)” at the website below.  
[https://web.casio.com/app/en/music\\_space/support/connect.html](https://web.casio.com/app/en/music_space/support/connect.html)
- 3. Launch the MIDI-compatible app on your smart device.**
  - When using CASIO’s dedicated app, if a successful connection is made, the message “Connecting” will appear on the smart device screen, followed by the message “Connected”.

## Outputting the Digital Piano's Sound to an Amplifier or Audio Equipment

When connected to an audio device or an amplifier for musical instruments, you can enjoy performances with more powerful volume and sound quality in line with the speaker capabilities of those devices. To make a connection, use a commercially available connection cord.

### IMPORTANT!

- Turn off all external devices when connecting. Also, keep the volume settings of the Digital Piano and external devices turned down to minimum when turning the power On/Off.
- After connecting, turn on the power to the Digital Piano and the external device, in that order.
- If the sound of this Digital Piano played by an external device sounds distorted, turn down the volume of the Digital Piano.
- Set [Headphone Mode] to <Off> when connecting to audio or an amplifier.

### Connecting to Audio Equipment

Use a commercially available connection cord and make a connection as shown in the diagram. Use a stereo standard phone plug (TRS phone) to connect to the Digital Piano. A standard phone plug (TS phone) only produces one side of stereo output. Normally, switch the input selector of your audio device to the connected terminal (AUX IN etc.).

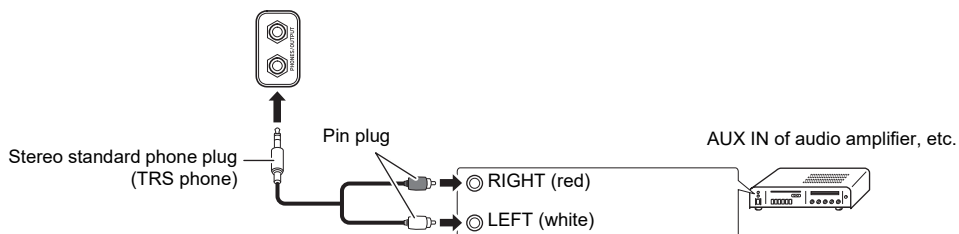

### Connecting to a Musical Instrument Amplifier

Depending on the device you are connecting to, use a commercially available connection cord to make a connection as shown in the diagram. Make sure that the side connected to the amplifier receives both left and right channel signals. If either is missing, only one side of the stereo output will be heard.

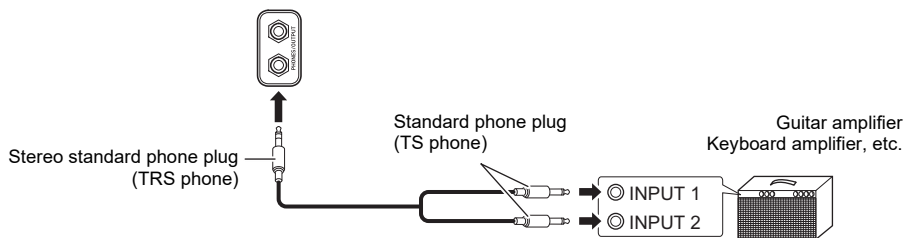

# Changing Settings

## Changing the Upper1 Part Settings

### Adjusting the Upper1 Part Volume

While holding down the “GRAND PIANO” button, press the A0 or B♭0 key.

Using the +/- Keys to Raise or Lower the Setting Value by 1 (operation type B)

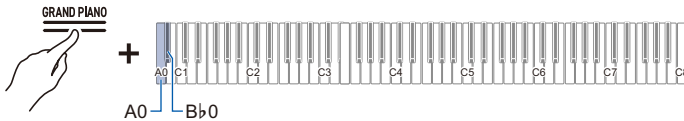

- Setting value: 0 (silence) to 42 (maximum volume)  
A separator tone sounds when the set value becomes a multiple of 10.
- Default value: 42

Key	Setting
A0	Lowers the Upper1 part volume by 1 (-)
B♭0	Raises the Upper1 part volume by 1 (+)
A0 + B♭0	Resets the Upper1 part volume to the default setting



## Changing the Upper2 Part Settings

### Adjusting the Upper2 Part Volume

While holding down the “GRAND PIANO” button, press the C#7 or D7 key.

Using the +/- Keys to Raise or Lower the Setting Value by 1 (operation type B)

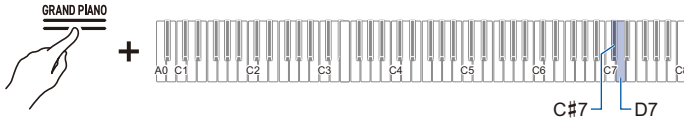

- Setting value: 0 (silence) to 42 (maximum volume)  
A separator tone sounds when the set value becomes a multiple of 10.
- Default value: 26

Key	Setting
C#7	Lowers the Upper2 part volume by 1 (-)
D7	Raises the Upper2 part volume by 1 (+)
C#7 + D7	Resets the Upper2 part volume to the default setting

### Fine-Tuning the Upper2 Part (Upper2 Detune)

Fine-tune the relative pitch of the Upper1 part to the Upper2 part.

While holding down the “GRAND PIANO” button, press the F7 or F#7 key.

Using the +/- Keys to Raise or Lower the Setting Value by 1 (operation type B)

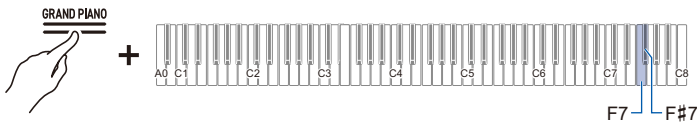

- Setting value: -99 cents to +99 cents (100 cents = 1 semitone)  
A separator tone sounds when the set value becomes a multiple of 10.
- Default value: 0 cents

Key	Setting
F7	Lowers the Upper2 part pitch by 1 cent (-)
F#7	Raises the Upper2 part pitch 1 cent (+)
F7 + F#7	Sets the pitch of the Upper2 part to the same pitch as the Upper1 part (default setting)

## Enabling/Disabling Upper2 Part Damper Pedal Effect

Sets whether the Upper2 part damper pedal effect is applied or not.

**While holding down the “GRAND PIANO” button, press the G7 key (Upper2 Damper).**

[Switching On/Off or Changing Setting Values Using a Single Key \(operation type D\)](#)

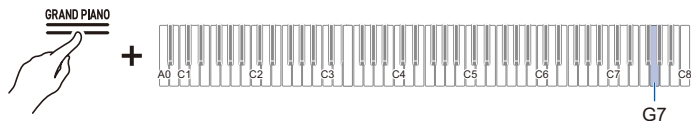

- Default value: Enable

Setting Value	Setting Details
Disable	Disables the Damper Pedal effect.
Enable	Enables the Damper Pedal effect.

## Changing the Lower Part Settings

### Adjusting the Lower Part Volume

While holding down the “GRAND PIANO” button, press the  $A\flat 7$  or  $A 7$  key.

Using the +/- Keys to Raise or Lower the Setting Value by 1 (operation type B)

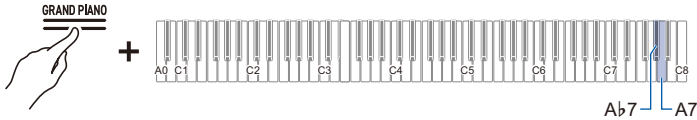

- Setting value: 0 (silence) to 42 (maximum volume)  
A separator tone sounds when the set value becomes a multiple of 10.
- Default value: 42

Key	Setting
$A\flat 7$	Lowers the Lower part volume by 1 (-)
$A 7$	Raises the Lower part volume by 1 (+)
$A\flat 7 + A 7$	Resets the Lower part volume to the default setting

### Fine-Tuning the Lower Part (Lower Detune)

Fine-tune the relative pitch of the Upper1 part to the Lower part.

While holding down the “GRAND PIANO” button, press the  $B\flat 7$  or  $B 7$  key.

Using the +/- Keys to Raise or Lower the Setting Value by 1 (operation type B)

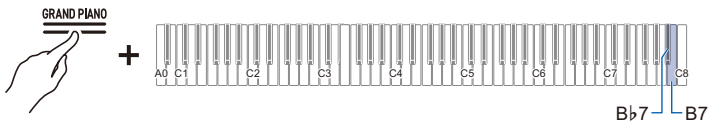

- Setting value: -99 cents to +99 cents (100 cents = 1 semitone)  
A separator tone sounds when the set value becomes a multiple of 10.
- Default value: 0 cents

Key	Setting
$B\flat 7$	Lowers the Lower part pitch by 1 cent (-)
$B 7$	Raises the Lower part pitch 1 cent (+)
$B\flat 7 + B 7$	Sets the pitch of the Lower part to the same as the Upper1 part (default setting)

## Enabling/Disabling Lower Part Damper Pedal Effect

Sets whether the Lower part damper pedal effect is applied or not.

**While holding down the “GRAND PIANO” button, press the C8 key (Lower Damper).**

[Switching On/Off or Changing Setting Values Using a Single Key \(operation type D\)](#)

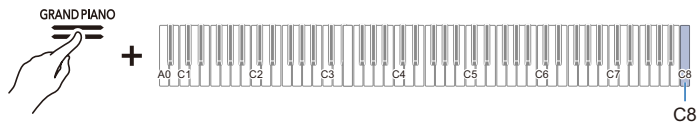

- Default value: Disable

Setting Value	Setting Details
Disable	Disables the Damper Pedal effect.
Enable	Enables the Damper Pedal effect.

## Saving the Digital Piano Settings (Auto Resume)

When [Auto Resume] is set to <On>, most settings are retained, even when the Digital Piano is turned off.

- The settings that are retained regardless of whether [Auto Resume] is <Enable> or <Disable> are as follows:  
A-tuning setting, Wireless Connection notification tone volume, touch button settings, notification tone settings, Auto Resume setting

**While holding down the “FUNCTION” button, press the A $\flat$ 7 key (Auto Resume).**

[Switching On/Off or Changing Setting Values Using a Single Key \(operation type D\)](#)

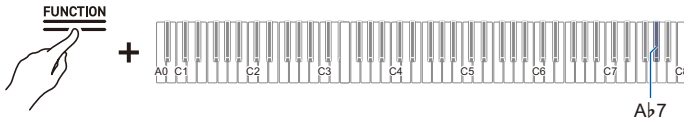

- Default value: Disable

Setting Value	Setting Details
Disable	Disables Auto Resume.
Enable	Enables Auto Resume.

## Restore Factory Defaults (Factory Reset)

You can initialize all system content on this Digital Piano, such as data and settings, and return the Digital Piano to the settings it had when it was shipped from the factory.

### 1. Press and hold the “FUNCTION” button.

Putting in Standby Mode, and Executing on Next Key Press (operation type E)

### 2. Press the A0 key (Factory Reset).

- The Digital Piano enters factory reset standby and the “FUNCTION” button blinks.
- Perform factory reset in the following way. To stop factory reset, release the “FUNCTION” button at this point.

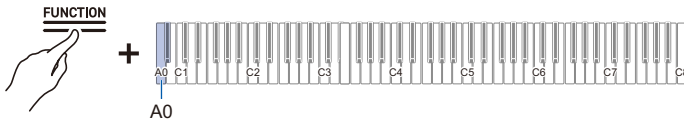

### 3. To execute factory reset, press the C1 key (Execute).

- Factory reset starts.

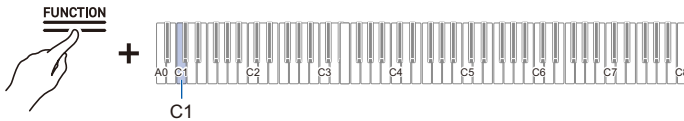

### 4. Release the “FUNCTION” button.

- Factory reset may take some time. Wait until completion. When factory reset is complete, all touch buttons on the panel of the Digital Piano (FUNCTION to GRAND PIANO) will light up.

## Adjusting Volume Balance

You can adjust the volume of keyboard performances, MIDI song playback, audio song playback, and wireless audio playback individually, relative to the overall volume.

### Keyboard Volume

While holding down the “FUNCTION” button, press the G3 or A♭3 key.

Using the +/- Keys to Raise or Lower the Setting Value by 1 (operation type B)

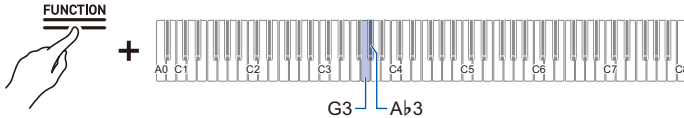

- Setting value: 0 (silence) to 42 (maximum volume)  
A separator tone sounds when the set value becomes a multiple of 10.
- Default value: 42

Key	Setting
G3	Lowers Keyboard Volume by 1 (-)
A♭3	Raises Keyboard Volume by 1 (+)
G3 + A♭3	Resets Keyboard Volume to default setting

## MIDI Song Volume

Adjusts the playback volume of built-in songs, user songs, MIDI Recorder songs, and USB flash drive songs.

**While holding down the “FUNCTION” button, press the F3 or F#3 key.**

Using the +/- Keys to Raise or Lower the Setting Value by 1 (operation type B)

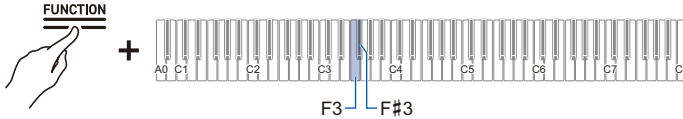

- Setting value: 0 (silence) to 42 (maximum volume)  
A separator tone sounds when the set value becomes a multiple of 10.
- Default value: 42

Key	Setting
F3	Lowers the playback volume of MIDI songs by 1 (–)
F#3	Raises the playback volume of MIDI songs by 1 (+)
F3 + F#3	Resets the playback volume of MIDI songs to the default setting

## Audio Song Playback Volume

Adjusts the playback volume of audio data (WAV and MP3 files) stored on USB flash drives.

**While holding down the “FUNCTION” button, press the D3 or E♭3 key.**

Using the +/- Keys to Raise or Lower the Setting Value by 1 (operation type B)

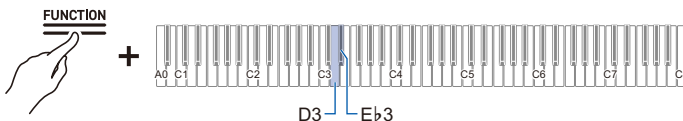

- Setting value: 0 (silence) to 42 (maximum volume)  
A separator tone sounds when the set value becomes a multiple of 10.
- Default value: 35

Key	Setting
D3	Lowers the playback volume of an audio song by 1 (–)
E♭3	Raises the playback volume of audio songs by 1 (+)
D3 + E♭3	Resets the playback volume of audio songs to the default setting



## Wireless Audio Playback Volume

Adjusts the playback volume of wireless audio.

**While holding down the “FUNCTION” button, press the B2 or C3 key.**

Using the +/- Keys to Raise or Lower the Setting Value by 1 (operation type B)

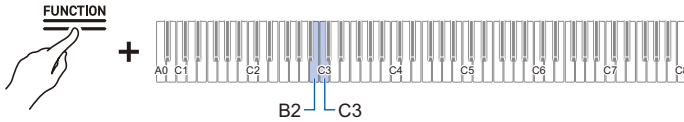

- Setting value: 0 (silence) to 42 (maximum volume)  
A separator tone sounds when the set value becomes a multiple of 10.
- Default value: 35

Key	Setting
B2	Lowers wireless audio playback volume by 1 (–)
C3	Raises wireless audio playback volume by 1 (+)
B2 + C3	Resets wireless audio playback volume to default setting

## Center Cancel Function

When [Center Cancel] is set to <On>, the vocals are cut from playback (cut or lowered). This function cancels centrally positioned sounds, so sounds other than vocals may also be cut. The degree of the effect depends on the audio data being played.

**While holding down the “FUNCTION” button, press the C#3 or E3 key.**

Switching On/Off or Changing Setting Values Using a Single Key (operation type D)

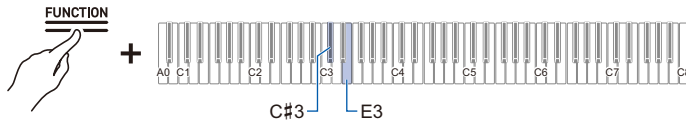

### Wireless Audio Center Cancel (C#3 key)

- Default value: Off

Setting Value	Setting Details
Off	Turns off Wireless Audio Center Cancel.
On	Turns on Wireless Audio Center Cancel. Cancels the center-positioned sound of the wireless audio.

### Audio Song Center Cancel (E3 key)

- Default value: Off

Setting Value	Setting Details
Off	Turns off Audio Song Center Cancel.
On	Turns on Audio Song Center Cancel. Cancels the center-positioned sound of the audio song.

## Changing MIDI Settings

### Local Control

When [Local Control] is set to <Off>, MIDI data is output from this Digital Piano, but the Digital Piano itself does not emit sound. This setting is for sending MIDI data to external devices only.

**While holding down the “FUNCTION” button, press the F6 key (Local Control).**

Switching On/Off or Changing Setting Values Using a Single Key (operation type D)

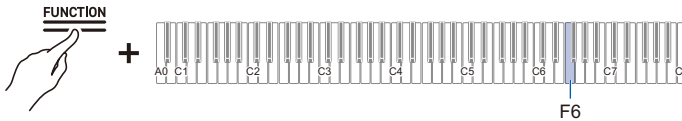

- Default value: On

Setting Value	Setting Details
Off	Turns off Local Control.
On	Turns on Local Control.

### Keyboard Channel

Sets the MIDI channel to be used when sending keyboard performance information from this Digital Piano to an external device.

**While holding down the “FUNCTION” button, press the F#6 or G6 key.**

Using the +/- Keys to Raise or Lower the Setting Value by 1 (operation type B)

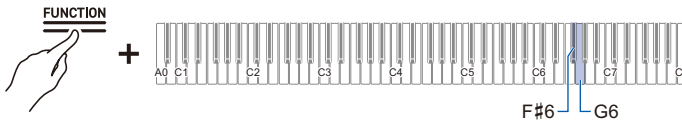

- Setting value: 1ch to 16ch
- Default value: 1ch

Key	Setting
F#6	Lowers the Keyboard Channel by 1 (-)
G6	Raises the Keyboard Channel by 1 (+)
F#6 + G6	Resets the Keyboard Channel to the default setting

## Hi-Res Velocity MIDI OUT

Set high-resolution MIDI output for touch strength (Velocity) to <Enable> or <Disable> when playing the keyboard.

**While holding down the “FUNCTION” button, press the A $\flat$ 6 key (Hi-Res Velocity MIDI OUT).**

Switching On/Off or Changing Setting Values Using a Single Key (operation type D)

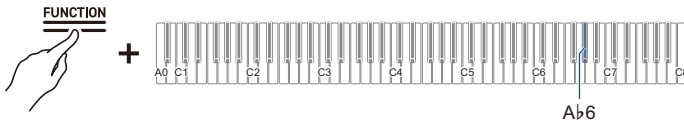

- Default value: Disable

Setting Value	Setting Details
Disable	Disables Hi-Res Velocity MIDI OUT.
Enable	Enables Hi-Res Velocity MIDI OUT.

## Main Digital Piano Settings

### Power On Alert

Set whether [Power On Alert] is <Enable> or <Disable>.

For more information, see “[Power On Alert](#)”.

**While holding down the “FUNCTION” button, press the F#7 key (Power On Alert).**

Switching On/Off or Changing Setting Values Using a Single Key (operation type D)

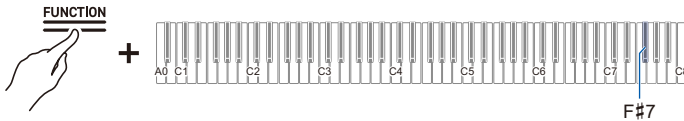

- Default value: Enable

Setting Value	Setting Details
Disable	Disables Power On Alert.
Enable	Enables Power On Alert.

### Auto Power Off

Set whether [Auto Power Off] is <Enable> or <Disable>.

For more information, see “[Auto Power Off Function](#)”.

**While holding down the “FUNCTION” button, press the B♭0 key (Auto Power Off).**

Switching On/Off or Changing Setting Values Using a Single Key (operation type D)

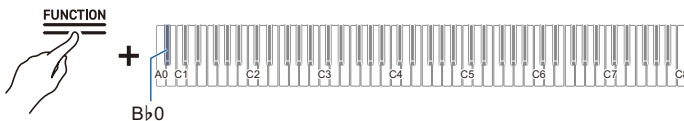

- Default value: Enable

Setting Value	Setting Details
Disable	Disables Auto Power Off.
Enable	Enables Auto Power Off.

### **WARNING**

If [Auto Power Off] is set to <Disable>, the product does not automatically turn off and continues to use power.

## Touch Button Luminosity

While holding down the “FUNCTION” button, press the B♭6 key (Touch Button Luminosity).

Switching On/Off or Changing Setting Values Using a Single Key (operation type D)

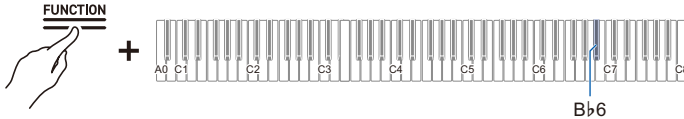

- Default value: 2

Setting Value	Setting Details
1	Dims touch button luminosity.
2	Brightens touch button luminosity.

## Left Panel Touch Button Sensitivity

While holding down the “FUNCTION” button, press the B6 or C7 key.

Using the +/- Keys to Raise or Lower the Setting Value by 1 (operation type B)

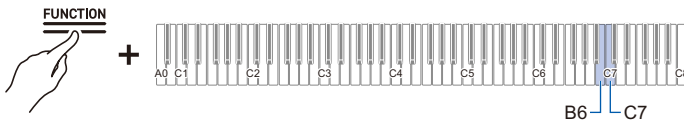

- Setting value: -1 (low sensitivity) to 0 (standard) to +1 (high sensitivity)
- Default value: 0

Key	Setting
B6	Lowers touch button sensitivity by 1 (-)
C7	Raises touch button sensitivity by 1 (+)

## Panel Lock

Setting [Panel Lock] to <Enable> locks button operations\*. When set to <Auto>, operation is automatically locked during performances only, preventing accidental operation during a performance.

\* Excludes the power button and the unlocking of Panel Lock.

**While holding down the “FUNCTION” button, press the C8 key (Panel Lock).**

Switching On/Off or Changing Setting Values Using a Single Key (operation type D)

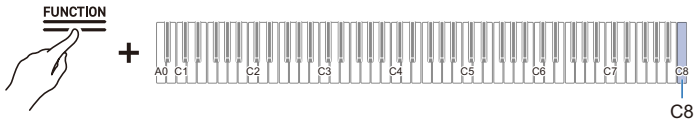

- Default value: Disable

Setting Value	Notification Tone	Setting Details
Disable	Tone for Off	Unlocks panel lock.
Enable	1 notification tone	Always locked operation.
Auto	2 notification tones	Locks operation only during performances.

## Switching Panel Light Settings

**While holding down the “FUNCTION” button, press the G7 key (Panel Light setting).**

Switching On/Off or Changing Setting Values Using a Single Key (operation type D)

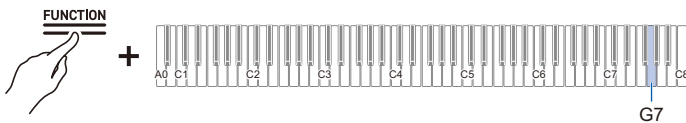

- Default value: 15 sec.

Setting Value	Notification Tone	Setting Details
Off	Tone for Off	Touch button light does not go off.
5 sec.	1 notification tone	If the set time elapses without a left panel operation, all touch buttons will turn off.
15 sec.	2 notification tones	
30 sec.	3 notification tones	
60 sec.	4 notification tones	
120 sec.	5 notification tones	

## Notification Tone Volume

While holding down the “FUNCTION” button, press the A7 or B♭7 key.

Using the +/- Keys to Raise or Lower the Setting Value by 1 (operation type B)

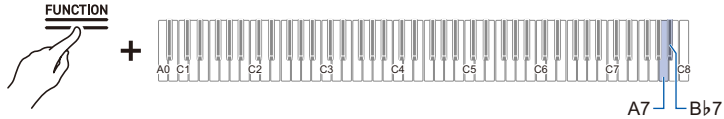

- Set value: 0 (silence) to 10 (maximum volume)
- Default value: 5

Key	Setting
A7	Lowers the notification tone volume by 1 (-)
B♭7	Raises the notification tone volume by 1 (+)
A7 + B♭7	Resets the notification tone volume to the default setting

## Notification Tone Set Selection

You can choose your favorite notification tones from three different notification tone sets.

While holding down the “FUNCTION” button, press the B7 key (Notification Tone Set selection).

Switching On/Off or Changing Setting Values Using a Single Key (operation type D)

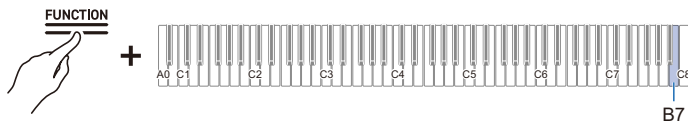



## Volume Sync Equalizer

Automatically corrects the sound quality in response to the loud or quiet setting of the volume knob. Bass and treble will be heard clearly even at low volumes.

**While holding down the “FUNCTION” button, press the F7 key (Volume Sync Equalizer).**

Switching On/Off or Changing Setting Values Using a Single Key (operation type D)

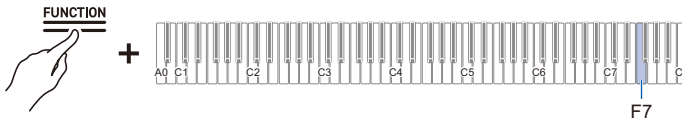

- Default value: Medium

Setting Value	Notification Tone	Setting Details
Off	Tone for Off	Does not compensate for sound quality.
Weak	1 notification tone	Weakly compensates for sound quality.
Medium	2 notification tones	Standard correction.
Strong	3 notification tones	Strongly compensates for sound quality.

## Speaker Out

Set whether or not sound is emitted from the Digital Piano's speakers.

**While holding down the “FUNCTION” button, press the E $\flat$ 7 key (Speaker Out).**

Switching On/Off or Changing Setting Values Using a Single Key (operation type D)

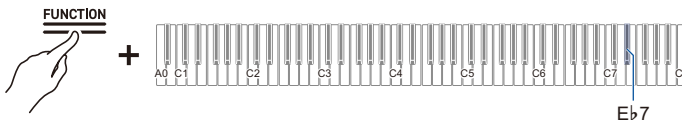

- Default value: Auto

Setting Value	Notification Tone	Setting Details
Disable	Tone for Off	No sound is emitted from the Digital Piano's speakers.
Enable	1 notification tone	Sound is emitted from the Digital Piano's speakers.
Auto	2 notification tones	When a plug is inserted into a PHONES/OUTPUT jack, no sound is emitted from the Digital Piano's speakers. When no plug is inserted, sound is emitted from the Digital Piano.

## Headphone Mode

When using headphones, this reproduces the natural sound that reaches your ears when you play an acoustic piano.

**While holding down the “FUNCTION” button, press the E7 key (Headphone Mode).**

Switching On/Off or Changing Setting Values Using a Single Key (operation type D)

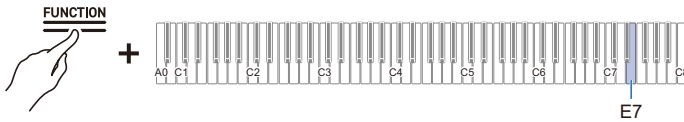

- Default value: On

Setting Value	Setting Details
Off	Turns off Headphone Mode.
On	Turns on Headphone Mode.

### NOTE

- The Headphone Mode is turned On when a plug is inserted into one of the PHONES/OUTPUT jacks.

## Troubleshooting

### Touch buttons are not responding.

- Cause:
- Gloved hands, fingernails, a stylus, etc. were used to touch the buttons.
  - The touch button sensitivity setting is not appropriate.

- Solution:
- Firmly touch the touch buttons with bare fingers.
  - Change the touch button sensitivity setting. For more information, see [“When Touch Buttons Do Not Respond”](#).

### No sound is produced when the keys are pressed.

- Cause:
- The volume is turned down with the volume knob.
  - Headphones are connected. Or, the headphone conversion plug is left in the PHONES/OUTPUT jacks.
  - The [Local Control] setting is turned <Off>.
  - The [Speaker Out] setting is set to <Off>.

- Solution:
- Turn the volume knob.
  - Unplug the headphones or conversion plug from the PHONES/OUTPUT jacks.
  - Set the [Local Control] setting to <On>. For more information, see [“Local Control”](#).
  - Set the [Speaker Out] setting to <Auto> or <On>. For more information, see [“Speaker Out”](#).

### Sound is out of pitch.

- Cause:
- The keyboard key tone (Transpose) has been changed from the default setting.
  - The fine tuning (Tuning) setting for sound pitch is set to a frequency other than 440.0 Hz.
  - Octave shift is set.
  - Scale Tuning is set to something other than the equal temperament.

- Solution:
- Reset [Transpose] to the default setting. Or, turn the power off and then back on. For details, see [“Changing the Pitch in Semitone Steps \(Transpose\)”](#).
  - Set the [Tuning] setting to 440.0 Hz. Upper2 Detune: Lower Restore Detune to the default setting. For details, see [“Fine-tuning \(A-tuning\)”](#) and [“Fine-Tuning the Upper2 Part \(Upper2 Detune\)”](#), [“Fine-Tuning the Lower Part \(Lower Detune\)”](#) for more information.
  - Set the Octave Shift setting to 0. For details, see [“Shifting by Octaves \(Octave Shift\)”](#).
  - Set the Scale Tuning setting to equal Temperament.

### Pressing the pedal has no effect.

- Cause:
- The pedal cord is not properly connected to the PEDAL UNIT jack. Or, the plug connector is not completely plugged in.

- Solution:
- Check that the pedal cord is properly connected and that the plug is firmly inserted into the jack.

---

**Sound does not become stronger or weaker when I change the way I play (touch).**

---

Cause: [Touch Response] is set to <Off>.

Solution: Set [Touch Response] to a setting other than <Off>. For details, see “[Changing the Volume Made by the Strength of Pressure Placed on a Key \(Touch Response\)](#)”.

---

**The tone of the sound, effects, and so forth, do not change (i.e., the Digital Piano does not return to its default settings), even after turning the power off and back on again.**

---

Cause: [Auto Resume] is set to <Enable>.

Solution: Turn [Auto Resume] to <Disable> then turn the power off and back on again. For more information, see “[Saving the Digital Piano Settings \(Auto Resume\)](#)”.

---

**Cannot send or receive MIDI when connected to a computer.**

---

Solution:

- Check that the Digital Piano is properly connected to the computer with a USB cable, or that the correct is selected in the settings of the computer's music software.
- Turn off the power to this Digital Piano and close the music software on your computer, then turn on the power to this Digital Piano and restart the music software on your computer.

---

**Some tones have the same timbre but slightly different sound quality and volume depending on keyboard position.**

---

Cause: This is a boundary between sound ranges caused by electronic processing called digital sampling\* and is not a malfunction.

\* This process records the original sound of the instrument in multiple ranges, including low, mid, and high ranges, and creates a single tone in order to reproduce the sound quality of each range of the original instrument.

---

**When pressing buttons, the sound that is being played is temporarily interrupted or the sound quality sounds slightly different.**

---

Cause: When using Layer, Duet, playing a Built-in Song, or using the recording function, multiple parts sound simultaneously. If you press buttons in such a case, the tone-specific internal effect settings will be automatically changed, and depending on the part, this phenomenon may occur, but it is not a malfunction.

---

**I don't know how to delete a User Song.**

---

Solution: Deletion of User Songs can be executed from a smart device connected to the Digital Piano. For details, see the instruction manual for the dedicated app.  
[https://web.casio.com/app/en/music\\_space/manual/](https://web.casio.com/app/en/music_space/manual/)

---

**I can't play songs recorded directly to a USB Flash Drive.**



---



Solution: Try formatting the USB flash drive in exFAT format on your computer and then formatting it on the instrument. For more information, see “[Formatting a USB Flash Drive](#)”.



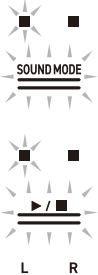
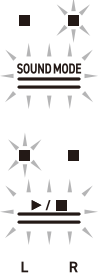

---

## Error Display List

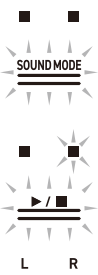
The touch buttons and indicators blink as shown in the illustration below.

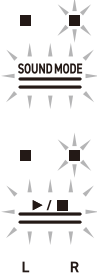
Display	Cause	Solution
	A USB flash drive is not properly inserted into the USB Type A port on the Digital Piano.	Correctly insert a USB flash drive into the USB Type A port.
	A USB flash drive was removed or inserted during operation.	Do not move USB flash drives while the Digital Piano is in operation.
	The USB flash drive is protected.	Cancel the protection of the USB flash drive.
	The USB flash drive contains antivirus software.	Use a USB flash drive that does not contain antivirus software.
	There are no files in the target folder that can be read or played.	Move the file you want to load or play to the target folder for loading. For more information, see <a href="#">“Copying MIDI Song Data to a USB Flash Drive Using a Computer”</a> and <a href="#">“Copying Audio Data (WAV, MP3) to a USB Flash Drive Using a Computer”</a> .
	Tried to save data to a USB flash drive when there was no recording data.	Record and then save.
	You are trying to save different data using the same name as a read-only file on the USB flash drive.	<ul style="list-style-type: none"> <li>• Rename the file on the USB flash drive before saving.</li> <li>• Remove the read-only attribute from the file on the USB flash drive and overwrite the file.</li> <li>• Use a different USB flash drive.</li> </ul>

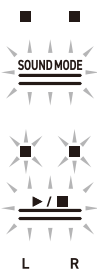
Display	Cause	Solution
	<p>Insufficient free space on USB flash drive.</p>	<ul style="list-style-type: none"> <li>• Increase free space by deleting files stored on the USB flash drive.</li> <li>• Use a different USB flash drive.</li> </ul>
	<p>You attempted to start recording beyond the maximum number of songs (99) on the Audio Recorder. TAKE99.WAV or TAKE99.MP3 is already in the AUDIOREC folder on the USB flash drive.</p>	<p>Using a computer, move TAKE**.WAV(** = 01-99) or TAKE**.MP3 (** = 01-99) in the AUDIOREC folder of the USB flash drive to another folder or drive.</p>
	<p>You attempted to load or play a file in SMF format 2.</p>	<p>The SMF format that can be loaded and played back by this Digital Piano is "0" or "1".</p>
	<p>The size of the SMF on the USB flash drive is too large to load into the Digital Piano or play on the Digital Piano.</p>	<p>The maximum size of SMF that can be loaded and played back by this Digital Piano is approximately 100 KB.</p>

Display	Cause	Solution
	<p>Data on the USB flash drive is corrupted.</p>	<p>–</p>
	<p>There is insufficient free memory space in the Digital Piano for converting MIDI recorder songs to SMF and saving them to a USB flash drive.</p>	<ul style="list-style-type: none"> <li>• Reduce the data size of the song.</li> <li>• Erase data tracks that are not needed.</li> </ul>
	<p>The version of the file on the USB flash drive is not supported by the Digital Piano.</p>	<p>Prepare a version of the file that is supported by the Digital Piano.</p>
	<p>The format of the USB flash drive is not compatible with this Digital Piano.</p>	<ul style="list-style-type: none"> <li>• Use a computer or other device to change the USB flash drive to a format compatible with this Digital Piano. For more information, see <a href="#">“Formatting a USB Flash Drive”</a>.</li> <li>• Use a different USB flash drive.</li> </ul>
	<p>The USB flash drive is corrupted.</p>	<p>Use a different USB flash drive.</p>

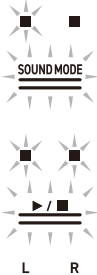
Display	Cause	Solution
	The Wireless MIDI & audio adaptor is not inserted into the USB Type A port.	Insert the Wireless MIDI & audio adaptor into the USB Type A port.



# Other Information

## Product Specifications

### ■ AP-300

<b>Model</b>	AP-300BK/AP-300BN/AP-300WE
<b>Keyboard</b>	88 keys
Settings	Hammer Response, Key Off Response (fixed according to the selected tone)
Duet	Changeable range (-2 to +2 octaves)
Transpose	-12 to 0 to +12 semitones
Octave Shift	-2 to 0 to +2 octaves
<b>Sound source</b>	
Number of tones	19 (18 tones for all keys + 1 bass tone for the lower part) <ul style="list-style-type: none"> <li>• Layering possible (except for bass tone)</li> <li>• Splitting possible (bass tone only for the lower part)</li> </ul>
Maximum Polyphony	192 notes
Touch Response function	5 sensitivity settings, Off
Tuning	415.5 Hz to 440.0 Hz to 465.9 Hz (in 0.1 Hz increments)
Temperament	Equal Temperament + 16 types
<b>Acoustic Simulator</b>	String Resonance, Damper Resonance, Damper Noise, Key On Action Noise, Key Off Action Noise, Lid Simulator
<b>Digital Effects</b>	
Sound Mode Effects	Hall Simulator (4 types), Reverb (4 types), Surround (1 type)
Other Effects	Chorus (4 types), Brilliance (-12 to 0 to +12), Headphone Mode
<b>Demo songs</b>	1 song
<b>Music Library</b>	
Built-in Songs	60 songs
User Songs	10 songs (max. approx. 100 KB per song, approx. 1 MB for 10 songs)*. * The stated capacity is the equivalent of 1 KB = 1024 bytes, 1 MB = 1024 <sup>2</sup> bytes.
Song volume	Adjustable (also used for recording function)
Part On/Off	L, R
<b>MIDI Recorder</b>	Real-time recording and playback as MIDI data
Number of songs	1 song
Number of recording tracks	2 tracks
Capacity	Approximately 10,000 notes total
Recording Medium	Built-in flash memory
Song volume	Adjustable (also used for Music Library)

<b>Audio Recorder</b>	Real-time recording and playback as audio data
Number of songs	99 songs (files)
File format	Recording/Playback: WAV format (linear PCM, 16 bit, 44.1 kHz, stereo) Playback only: MP3 format (MPEG-1 Audio Layer 3, 32 to 320 kbps/variable bit rate (VBR) supported, 44.1 kHz / 48 kHz, mono/stereo)
Maximum recording time	Approximately 25 minutes per file
Recording Medium	USB Flash Drive
<b>Metronome</b>	
Beat bell	Off, 1-9 (beats)
Tempo range	20 to 255
Tempo Markings	9 types
Volume	Adjustable
<b>Pedal</b>	Damper (Off, Half, On), Sostenuto (Off, On), Soft (Off, Half, On)
<b>Other Functions</b>	<ul style="list-style-type: none"> <li>• Auto Resume</li> <li>• Panel Lock</li> <li>• Notification Tone settings (switchable from set 1 to set 3, adjustable volume)</li> </ul>
<b>MIDI</b>	16 ch multi-timbre reception
<b>Input-Output Jacks</b>	
PHONES/OUTPUT jacks	Stereo standard phone jack (TRS phone) × 2
Power supply terminal	DC 24V
USB ports	Type A, Type B
Pedal Unit jack	Special shape
<b>Acoustics</b>	
Amplifier output	16W + 16W (maximum output 20W + 20W)
Speakers	12 cm × 2
<b>Power</b>	AC adaptor AD-E24250LW
Auto Power Off	Approx. 20 minutes, cancelable
<b>Power Consumption</b>	24V --- 20W
<b>Size</b>	Piano and Stand: 140.1 (W) × 44.0 (D) × 86.9 (H) cm (55 3/16 × 17 5/16 × 34 3/16 inch)
<b>Weight</b>	Piano, Stand and Music Stand: approx. 47.1 kg (103.8 lbs)

- For continued improvement, the specifications and design are subject to change without notice.

## ■ AP-S200

<b>Model</b>	AP-S200BK/AP-S200BN/AP-S200WE
<b>Keyboard</b>	88 keys
Settings	Hammer Response, Key Off Response (fixed according to the selected tone)
Duet	Changeable range (-2 to +2 octaves)
Transpose	-12 to 0 to +12 semitones
Octave Shift	-2 to 0 to +2 octaves
<b>Sound source</b>	
Number of tones	19 (18 tones for all keys + 1 bass tone for the lower part) <ul style="list-style-type: none"> <li>• Layering possible (except for bass tone)</li> <li>• Splitting possible (bass tone only for the lower part)</li> </ul>
Maximum Polyphony	192 notes
Touch Response function	5 sensitivity settings, Off
Tuning	415.5 Hz to 440.0 Hz to 465.9 Hz (in 0.1 Hz increments)
Temperament	Equal Temperament + 16 types
<b>Acoustic Simulator</b>	String Resonance, Damper Resonance, Damper Noise, Key On Action Noise, Key Off Action Noise
<b>Digital Effects</b>	
Sound Mode Effects	Hall Simulator (4 types), Reverb (4 types), Surround (1 type)
Other Effects	Chorus (4 types), Brilliance (-12 to 0 to +12), Headphone Mode
<b>Demo songs</b>	1 song
<b>Music Library</b>	
Built-in Songs	60 songs
User Songs	10 songs (max. approx. 100 KB per song, approx. 1 MB for 10 songs)*. * The stated capacity is the equivalent of 1 KB = 1024 bytes, 1 MB = 1024 <sup>2</sup> bytes.
Song volume	Adjustable (also used for recording function)
Part On/Off	L, R
<b>MIDI Recorder</b>	Real-time recording and playback as MIDI data
Number of songs	1 song
Number of recording tracks	2 tracks
Capacity	Approximately 10,000 notes total
Recording Medium	Built-in flash memory
Song volume	Adjustable (also used for Music Library)
<b>Audio Recorder</b>	Real-time recording and playback as audio data
Number of songs	99 songs (files)
File format	Recording/Playback: WAV format (linear PCM, 16 bit, 44.1 kHz, stereo) Playback only: MP3 format (MPEG-1 Audio Layer 3, 32 to 320 kbps/variable bit rate (VBR) supported, 44.1 kHz / 48 kHz, mono/stereo)
Maximum recording time	Approximately 25 minutes per file
Recording Medium	USB Flash Drive

<b>Metronome</b>	
Beat bell	Off, 1-9 (beats)
Tempo range	20 to 255
Tempo Markings	9 types
Volume	Adjustable
<b>Pedal</b>	Damper (Off, Half, On), Sostenuto (Off, On), Soft (Off, On)
<b>Other Functions</b>	<ul style="list-style-type: none"> <li>• Auto Resume</li> <li>• Panel Lock</li> <li>• Notification Tone settings (switchable from set 1 to set 3, adjustable volume)</li> </ul>
<b>MIDI</b>	16 ch multi-timbre reception
<b>Input-Output Jacks</b>	
PHONES/OUTPUT jacks	Stereo standard phone jack (TRS phone) × 2
Power supply terminal	DC 24V
USB ports	Type A, Type B
Pedal Unit jack	Special shape
<b>Acoustics</b>	
Amplifier output	16W + 16W (maximum output 20W + 20W)
Speakers	12 cm × 2
<b>Power</b>	AC adaptor AD-E24250LW
Auto Power Off	Approx. 20 minutes, cancelable
<b>Power Consumption</b>	24V --- 20W
<b>Size</b>	Piano and Stand: 139.3 (W) × 29.9 (D) × 80.2 (H) cm (54 13/16 × 11 3/4 × 31 9/16 inch)
<b>Weight</b>	Piano, Stand and Music Stand: approx. 34.0 kg (75.0 lbs)

- For continued improvement, the specifications and design are subject to change without notice.

## ■ Optional Products

For more information on optional products, see “[Latest Support Information](#)”.

## ■ About Music Score data

You can download music score data as a PDF file from the CASIO website. You will then be able to view music scores on your smart device. You can jump from the PDF file table of contents directly to the music score you want, and you can print out scores as needed.

Refer to “[Latest Support Information](#)” for music score PDF files.

## Latest Support Information

AP-300

<https://support.casio.com/global/en/emi/manual/AP-300/>



AP-S200

<https://support.casio.com/global/en/emi/manual/AP-S200/>



## About the Contents of this Manual

- Unauthorized copying of this manual, in whole or in part, is prohibited. Note that copyright law prohibits the use of any other information without our permission, except for personal use.
- Be advised that we will not be liable for any loss, lost profits, or any claims from third parties resulting from the use of this manual or this device.
- The contents of this manual are subject to change without notice.
- Illustrations in this manual may differ from the actual product.

## Trademarks and Registered Trademarks

- The Bluetooth® word mark and logos are registered trademarks owned by Bluetooth SIG, Inc. and any use of such marks by CASIO COMPUTER CO., LTD. is under license. Other trademarks and trade names are those of their respective owners.
- Company and product names used in this manual may be registered trademarks of others.

## Operating Precautions

### ■ Environment

- Place the Digital Piano onto a stable and flat surface.
- To prevent the formation of mold, set up the product in a well-ventilated location where the temperature and humidity ranges shown below are maintained.
  - Recommended temperature range: 15 to 25°C
  - Recommended humidity range: 40 to 60% RH
- Do not set up the product in locations subject to extreme variations in temperature and/or humidity. Doing so can cause metal components to rust, coatings to degrade, and components to warp and split.

### ■ User Maintenance

- Wipe the product with a soft, dry cloth. Do not use a tissue, which can cause scratching.
- When soiling is more serious, moisten a soft cloth with a weak solution of water and a mild neutral detergent, wring out all excess moisture from the cloth, and then wipe the product. After that, wipe again with a separate soft dry cloth.
- Do not use any cleaning agents, chlorine disinfectants, sanitizing wipes, or other items that include benzene, organic solvents, alcohol, or other solvents for cleaning. Doing so can cause discoloration, deformation, paint peeling, cracking, etc.

### ■ Sterilization and Disinfection

- After wiping the product two or three times with a non-alcohol sanitizing wipe, use a soft, dry cloth to wipe it dry.
- Note that failure to wipe the product dry can cause streaks to remain.
- If the product is used by multiple parties, hand disinfection before each use is recommended.

### ■ Included and Optional Accessories

Use only accessories that are specified for use with this product. Use of unauthorized accessories creates the risk of fire, electric shock, and personal injury.

### ■ Weld Lines

Lines may be visible on the exterior of the product. These are “weld lines” that result from the plastic molding process. They are not cracks or scratches.

### ■ AC Adaptor Handling Precautions

- Never connect the AC adaptor (JEITA Standard, with unified polarity plug) that is specified with this Digital Piano to any other device besides this Digital Piano. Doing so creates the risk of malfunction.
- The AC adaptor cannot be repaired. If your AC adaptor malfunctions or becomes damaged, contact your original retailer or a CASIO Service Center.
- AC adaptor operating environment: Temperature: 0 to 40°C  
Humidity: 10% to 90% RH
- Output polarity: 
- Use of a different type AC adaptor can cause smoking or malfunction.

## ■ About the panel

Operating the panel when it is dusty or dirty may scratch it.

Gently wipe the panel with a soft, clean cloth to remove dust and dirt before use.

Use your fingers to operate the panel. Using fingernails or sharp objects may scratch the surface.

## ■ Disconnect Protection Precautions

- (1) Never pull on the cord with excessive force.
- (2) Never repeatedly pull on the cord.
- (3) Never twist the cord at the base of the plug or connector.

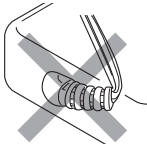

- (4) Loop and bundle the power cord, but never wind it around the AC adaptor.

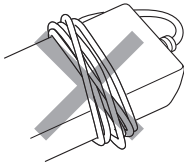

- (5) Before moving the Digital Piano, be sure to unplug the AC adaptor from the power outlet.

## ■ Locating the AC Adaptor for Use

- When using the AC adaptor, put in a location that satisfies the conditions below.
  - A location free of splashing liquids.  
The AC adaptor is designed for indoor use only. Do not put it in a location where it may become wet and do not place a vase or any other container of liquid on top of it.
  - A location that is not humid.
  - A roomy, well ventilated location.  
Do not cover the AC adaptor with newspaper, table cloth, curtain, or any other type of fabric.
  - Use a power outlet that is located near the Digital Piano.  
This will let you immediately unplug from the power outlet should any problem occur.
- When using the AC adaptor, place it on the floor with its label surface downwards. The AC adaptor becomes prone to emitting electromagnetic waves when the label surface is facing upwards.



# Various Lists

## Tone list

Timbre Name	Selection Key Name	Input-Output		Input Only	
		Program Change	Bank Select MSB	Program Change	Bank Select MSB
GRAND PIANO CONCERT	G3	0	16	0	0
GRAND PIANO BRIGHT	A $\flat$ 3	1	16	1	0
GRAND PIANO MELLOW	A3	2	16	0	1
ROCK PIANO	B $\flat$ 3	3	16	1	1
JAZZ PIANO	B3	4	16	0	2
BALLAD PIANO	C4	5	16	0	4
ELEC.PIANO	C $\sharp$ 4	10	16	4	0
60'S E.PIANO	D4	13	16	4	1
DIGITAL E.PIANO 1	E $\flat$ 4	11	16	5	0
DIGITAL E.PIANO 2	E4	12	16	5	1
HARPSICHORD	F4	14	16	6	0
VIBRAPHONE	F $\sharp$ 4	15	16	11	0
STRINGS 1	G4	16	16	49	0
STRINGS 2	A $\flat$ 4	17	16	48	0
PIPE ORGAN	A4	18	16	19	0
JAZZ ORGAN	B $\flat$ 4	19	16	17	0
ELEC.ORGAN 1	B4	20	16	16	0
ELEC.ORGAN 2	C5	21	16	16	1
BASS (LOWER)	C $\sharp$ 5	22	16	32	0

### BASS (LOWER) Key Map

Key	Sound
C-1 – G $\sharp$ 0	Ghost Note
A0 – C5	Normal Finger w/ Off Noise
C $\sharp$ 5 – G9	Harmonics

### NOTE

- BASS (LOWER) is a tone dedicated to the bass section and cannot be sounded alone.
- BASS (LOWER) includes key ranges outside the range that can be played on the Digital Piano's keyboard. Keys outside the range can be sounded by external MIDI input.

## Demo Song List

The length of a song may differ from its original.

### AP-300

Timbre	Song Title
GRAND PIANO CONCERT	Étude Op.10-1 / F.F.Chopin

### AP-S200

Timbre	Song Title
GRAND PIANO CONCERT	Valse Op.42 / F.F.Chopin

## Music Library List

Number	Selection Key Name	Song Title
1	C#3	Nocturne Op.9-2
2	D3	Fantaisie-Impromptu Op.66
3	E♭3	Étude Op.10-3 "Chanson de l'adieu"
4	E3	Étude Op.10-5 "Black Keys"
5	F3	Étude Op.10-12 "Revolutionary"
6	F#3	Étude Op.25-9 "Butterflies"
7	G3	Prélude Op.28-7
8	A♭3	Valse Op.64-1 "Petit Chien"
9	A3	Valse Op.64-2
10	B♭3	Moments Musicaux 3
11	B3	Impromptu Op.90-2
12	C4	Marche Militaire 1 (Duet)
13	C#4	Frühlingslied [Lieder Ohne Worte Heft 5]
14	D4	Fröhlicher Landmann [Album für die Jugend]
15	E♭4	Von fremden Ländern und Menschen [Kinderszenen]
16	E4	Träumerei [Kinderszenen]
17	F4	Tambourin
18	F#4	Menuet BWV Anh.114 [Clavierbüchlein der Anna Magdalena Bach]
19	G4	Inventio 1 BWV 772
20	A♭4	Inventio 8 BWV 779
21	A4	Inventio 13 BWV 784
22	B♭4	Praeludium 1 BWV 846 [Das Wohltemperierte Klavier 1]
23	B4	Le Coucou
24	C5	Gavotte
25	C#5	Sonatina Op.36-1 1st Mov.
26	D5	Sonatine Op.20-1 1st Mov.
27	E♭5	Sonate K.545 1st Mov.
28	E5	Sonate K.331 3rd Mov. "Turkish March"

Number	Selection Key Name	Song Title
29	F5	Rondo K.485
30	F#5	Für Elise
31	G5	Marcia alla Turca
32	A♭5	Sonate Op.13 "Pathétique" 1st Mov.
33	A5	Sonate Op.13 "Pathétique" 2nd Mov.
34	B♭5	Sonate Op.13 "Pathétique" 3rd Mov.
35	B5	Sonate Op.27-2 "Moonlight" 1st Mov.
36	C6	Rhapsodie 2
37	C#6	Waltz Op.39-15 (Duet)
38	D6	Liebesträume 3
39	E♭6	Blumenlied
40	E6	La Prière d'une Vierge
41	F6	Csikos Post
42	F#6	Humoresque Op.101-7
43	G6	Melodie [Lyrische Stücke Heft 2]
44	A♭6	Sicilienne Op.78
45	A6	Berceuse [Dolly] (Duet)
46	B♭6	Arabesque 1
47	B6	La Fille aux Cheveux de Lin [Préludes]
48	C7	Passepied [Suite bergamasque]
49	C#7	Gymnopédie 1
50	D7	Je Te Veux
51	E♭7	Salut d'Amour
52	E7	The Entertainer
53	F7	Maple Leaf Rag
54	F#7	L'arabesque [25 Étüden Op.100]
55	G7	La Styrienne [25 Étüden Op.100]
56	A♭7	Ave Maria [25 Étüden Op.100]
57	A7	Le retour [25 Étüden Op.100]
58	B♭7	La chevaleresque [25 Étüden Op.100]
59	B7	No.13 [Études de Mécanisme Op.849]
60	C8	No.26 [Études de Mécanisme Op.849]

# Keyboard Function List

## ■ Make basic settings such as tuning

Hold down the “FUNCTION” button and select key.

	Note name	Assigned Function
A0	A0	Factory Reset
	B>0	Auto Power Off
C1	B0	disable/enable
	C1	Execution
	C#1	Wireless Audio Pairing
	D1	Wireless Function
	E>1	Off/On
	E1	Wireless MIDI & audio adaptor
	F1	Connection notification tone volume
	F#1	(-)
	G1	(+)
	G1	Delete connection history
C2	A>1	Load SMF/MRF
	A1	Save SMF
	B>1	Save MRF
	B1	Delete SMF/MRF/Audio
	C2	Format
	C#2	
	D2	
	E>2	
	E2	
	F2	Duet Mode
F#2	Off/On/Pan	
G2	Left-side keyboard Octave Shift	
A>2	(-)	
A2	(+)	
B>2	Right-side keyboard Octave Shift	
B2	(-)	
C3	C3	(+)
	C#3	Wireless Audio Volume
	D3	(-)
	E>3	Wireless Audio Center Cancel
	E3	Off/On
	F3	Audio Song Volume
	F#3	(-)
	G3	(+)
	A>3	Audio Song Center Cancel
	A3	Off/On
C4	B>3	(-)
	B3	(+)
	C4	MIDI Recorder
	C#4	Audio Recorder
	D4	Audio Rec with MIDI playback
	E>4	
	E4	
	F4	
	F#4	Scale Tuning Selection
	G4	Scale Tuning base note
C5	A>4	Stretch tuning
	A4	Off/On
	B>4	
	B4	A-tuning
	C5	440.0 Hz
	C#5	442.0 Hz
	D5	-0.1 Hz
	E>5	+0.1 Hz
	E5	
	F5	
C6	F#5	
	G5	
	A>5	
	A5	
	B>5	
	B5	
	C6	
	C#6	
	D6	
	E>6	
C7	E6	
	F6	Local Control
	F#6	Off/On
	G6	Keyboard Channel
	A>6	(-)
	A6	(+)
	B>6	Hi-Res Velocity MIDI OUT
	B6	disable/enable
	C7	Touch Button Luminosity
	C#7	1/2
C8	D7	(-)
	E>7	(+)
	E7	Speaker Out
	F7	disable/enable/Auto
	F#7	Headphone Mode
	G7	Off/On
	A>7	Volume Sync Equalizer
	A7	Off/Weak/Medium/Strong
	B>7	Power On Alert
	B7	disable/enable
C8	C8	Panel Light setting
	C8	Auto Resume
C8	A7	Off/5 sec./15 sec./30 sec./60 sec./120 sec.
	A7	disable/enable
C8	B>7	Notification Tone Volume
	B>7	(-)
C8	B7	(+)
	B7	Notification Tone Set selection
C8	C8	1/2/3
	C8	Panel Lock
C8	C8	disable/enable/Auto
	C8	

## ■ Change Sound Mode Effects and other settings

Hold down the “SOUND MODE” button and select key.

Note name		Assigned Function	
A0	A0	Sound Mode Effects	N.Y.Club
	B♭0		Opera Hall
B0	Berlin Hall		
C1	C1		British Stadium
	C#1		Room
D1	Large Room		
E♭1	Hall		
E1	Stadium		
F1			
F#1			
G1			
A♭1			
A1			
B♭1			
B1			
C2	C2		
	C#2		
D2			
E♭2	Hall Simulator/Reverb depth	(-)	
E2		(+)	
F2	Wireless Audio Hall Simulator/Reverb depth	(-)	
F#2		(+)	
G2			
A♭2			
A2			
B♭2			
B2			
C3	C3	Brilliance	(-)
	C#3		(+)
D3	String Resonance		Tone
E♭3			Off
E3			1
F3			2
F#3	3		
G3	4		
A♭3	Damper Resonance		Tone
A3			Off
B♭3			1
B3			2
C4	C4	Acoustic Simulator	3
	C#4		4
D4	Damper Noise		Tone
E♭4			Off
E4			1
F4			2
F#4	3		
G4	4		
A♭4	Key On Action Noise		Tone
A4			Off
B♭4			1
B4			2
C5	C5	Key Off Action Noise	3
	C#5		4
D5	Key Off Action Noise		Tone
E♭5			Off
E5			1
F5			2
F#5	3		
G5	4		
A♭5	Lid Simulator (AP-300 only)		Tone
A5			Close
B♭5			Semi
B5			Full
C6	C6		Remove
	C#6		
D6			
E♭6			
E6			
F6			
F#6			
G6			
A♭6			
A6			
B♭6			
B6			
C7	C7	Chorus	Tone
	C#7		Light Chorus
D7	Chorus		
E♭7	Deep Chorus		
E7	Flanger		
F7			
F#7			
G7			
A♭7			
A7			
B♭7			
B7			
C8	C8		

## Change metronome and tempo settings

Hold down the “METRONOME” button and select key.

	Note name	Assigned Function
A0	A0	0
	B♭0	1
C1	B0	2
	C1	3
	C#1	4
	D1	5
	E♭1	6
	E1	7
	F1	8
	F#1	9
	G1	
	A♭1	
C2	A1	Metronome Volume (-)
	B♭1	(+)
	B1	
	C2	Largo
	C#2	Lento
	D2	Adagio
	E♭2	Andante
	E2	Moderato
	F2	Allargretto
	F#2	Allegro
G2	Vivace	
A♭2	Presto	
A2		
B♭2	Tap Tempo	
C3	B2	Tempo Change (-)
	C3	(+)
	C#3	Off
	D3	1 beat
	E♭3	2 beats
	E3	3 beats
	F3	4 beats
	F#3	5 beats
	G3	6 beats
	A♭3	7 beats
A3	8 beats	
B♭3	9 beats	
B3		
C4	C4	
	C#4	
	D4	
	E♭4	
	E4	
	F4	
	F#4	
	G4	
	A♭4	
	A4	
C5	B♭4	
	B4	
	C5	
	C#5	
	D5	
	E♭5	
	E5	
	F5	
	F#5	
	G5	
C6	A♭5	
	A5	
	B♭5	
	B5	
	C6	
	C#6	
	D6	
	E♭6	
	E6	
	F6	
C7	F#6	
	G6	
	A♭6	
	A6	
	B♭6	
	B6	
	C7	
	C#7	
	D7	
	C8	E♭7
E7		
F7		
F#7		
G7		
A♭7		
A7		
B♭7		
B7		
C8		

## Select a song

Hold down the “▶/■” button and select key.

Note name		Assigned Function	
A0	A0		0
	B#0		1
C1	B0	Song selection using song number	2
	C1		3
	C#1		4
	D1		5
	E#1		6
	E1		7
	F1		8
	F#1		9
	G1		
C2	A#1		
	A1		
	B#1	Song Playback Part selection	LR/LR
	B1		61 User 1
	C2		62 User 2
	C#2		63 User 3
	D2		64 User 4
	E#2	Music Library (User Song)	65 User 5
	E2		66 User 6
	F2		67 User 7
F#2	68 User 8		
G2	69 User 9		
A#2	70 User 10		
A2	MIDI Recorder Song		
B#2	USB Flash Drive song		
C3	B2	Song Select	(-)
	C#3		(+)
	C#3		1 Nocturne Op.9-2
	D3		2 Fantasia-Impromptu Op.66
	E#3		3 Etude Op.10-3 "Chanson de l'adieu"
	E3		4 Etude Op.10-5 "Black Keys"
	F3		5 Etude Op.10-12 "Revolutionary"
	F#3		6 Etude Op.25-9 "Butterflies"
	G3		7 Prélude Op.28-7
	A#3		8 Valse Op.84-1 "Petit Chien"
	A3		9 Valse Op.84-2
	B#3		10 Moments Musicaux 3
	C4	B3	
C4			12 Marche Militaire 1 (Duet)
C#4			13 Frühlingslied (Lieder Ohne Worte Heft 5)
D4			14 Fröhlicher Landmann (Album für die Jugend)
E#4			15 Von fremden Ländern und Menschen (Kinderszenen)
E4			16 Träumerei (Kinderszenen)
F4			17 Tambourin
F#4			18 Menuet BWV Anh.114 (Clavierbüchlein der Anna Magdalena Bach)
G4			19 Invenio 1 BWV 772
A#4			20 Invenio 8 BWV 779
A4			21 Invenio 13 BWV 784
B#4			22 Praeludium 1 BWV 846 [Das Wohltemperierte Klavier 1]
B4			23 Le Coucou
C5		C5	
	C#5		25 Sonatina Op.36-1 1st Mov.
	D5		26 Sonatine Op.20-1 1st Mov.
	E#5		27 Sonate K.545 1st Mov.
	E5		28 Sonate K.331 3rd Mov. "Turkish March"
	F5		29 Rondo K.485
	F#5		30 Für Elise
	G5		31 Marcia alla Turca
	A#5		32 Sonate Op.13 "Pathétique" 1st Mov.
	A5		33 Sonate Op.13 "Pathétique" 2nd Mov.
	B#5		34 Sonate Op.13 "Pathétique" 3rd Mov.
C6	B5		35 Sonate Op.27-2 "Moonlight" 1st Mov.
	C6		36 Rhapsodie 2
	C#6		37 Waltz Op.39-15 (Duet)
	D6		38 Liebesträume 3
	E#6		39 Blumenlied
	E6		40 La Prière d'une Vierge
	F6		41 Csikós Rag
	F#6		42 Humoresque Op.101-7
	G6		43 Melodie [Lyrische Stücke Heft 2]
	A#6		44 Sicilienne Op.78
C7	A6		45 Berceuse [Dolly] (Duet)
	B#6		46 Arabesque 1
	B6		47 La Fille aux Cheveux de Lin [Préludes]
	C7		48 Passepied [Suite bergamasque]
	C#7		49 Gymnopédie 1
	D7		50 Je Te Veux
	E#7		51 Salut d'Amour
	E7		52 The Entertainer
	F7		53 Maple Leaf Rag
	F#7		54 L'arabesque [25 Etudes Op.100]
C8	G7		55 La Styrienne [25 Etudes Op.100]
	A#7		56 Ave Maria [25 Etudes Op.100]
	A7		57 Le retour [25 Etudes Op.100]
	B#7		58 La chevaleresque [25 Etudes Op.100]
	B7		59 No.13 [Etudes de Mécanisme Op.849]
	C8		60 No.26 [Etudes de Mécanisme Op.849]

## ■ Selecting Songs During Demo Playback

Hold down the “▶/■” button and select key.

		Note name	Assigned Function
A0	A0	Demo song	1
	B#0		
C1	B0		
	C1		
	C#1		
	D1		
	E#1		
	E1		
	F1		
	F#1		
	G1		
	A#1		
C2	A1		
	B#1		
	B1		
	C2		
	C#2		
	D2		
	E#2		
	E2		
	F2		
	F#2		
C3	G2		
	A#2		
	A2		
	B#2		
	B2	Song Select	(-)
	C#3		(*)
	C#3		1 Nocturne Op.9-2
	D3		2 Fantaisie-impromptu Op.66
	E#3		3 Etude Op.10-3 "Chanson de l'adieu"
	E3		4 Etude Op.10-5 "Black Keys"
C4	F3		5 Etude Op.10-12 "Revolutionary"
	F#3		6 Etude Op.25-9 "Butterflies"
	G3		7 Prélude Op.28-7
	A#3		8 Valse Op.84-1 "Petit Chien"
	A3		9 Valse Op.84-2
	B#3		10 Moments Musicaux 3
	B3		11 Impromptu Op.90-2
	C4		12 Marche Militaire 1 (Duet)
	C#4		13 Frühlingslied (Lieder Ohne Worte Heft 5)
	D4		14 Fröhlicher Landmann [Album für die Jugend]
C5	E#4		15 Von fremden Ländern und Menschen [Kinderszenen]
	E4		16 Träumerei [Kinderszenen]
	F#4		17 Tambourin
	F4		18 Menuet BWV Anh.114 (Clavierbüchlein der Anna Magdalena Bach)
	G#4		19 Invenio 1 BWV 772
	A#4		20 Invenio 8 BWV 779
	A4		21 Invenio 13 BWV 784
	B#4		22 Praeludium 1 BWV 846 [Das Wohltemperierte Klavier 1]
	B4		23 Le Coucou
	C5		24 Gavotte
C6	C#5		25 Sonatina Op.36-1 1st Mov.
	D5		26 Sonatine Op.20-1 1st Mov.
	E#5		27 Sonate K.545 1st Mov.
	E5		28 Sonate K.331 3rd Mov. "Turkish March"
	F5		29 Rondo K.485
	F#5		30 Für Elise
	G5		31 Marcia alla Turca
	A#5		32 Sonate Op.13 "Pathétique" 1st Mov.
	A5		33 Sonate Op.13 "Pathétique" 2nd Mov.
	B#5		34 Sonate Op.13 "Pathétique" 3rd Mov.
C7	B5		35 Sonate Op.27-2 "Moonlight" 1st Mov.
	C6		36 Rhapsodie 2
	C#6		37 Waltz Op.39-15 (Duet)
	D6		38 Liebesträume 3
	E#6		39 Blumenlied
	E6		40 La Prière d'une Vierge
	F#6		41 Calkin Rag
	F6		42 Humoresque Op.101-7
	G#6		43 Melodie [Lyrische Stücke Heft 2]
	A#6		44 Sicilienne Op.78
C8	A6		45 Berceuse [Dolly] (Duet)
	B#6		46 Arabesque 1
	B6		47 La Fille aux Cheveux de Lin [Préludes]
	C7		48 Passepied [Suite bergamasque]
	C#7		49 Gymnopédie 1
	D7		50 Je Te Veux
	E#7		51 Salut d'Amour
	E7		52 The Entertainer
	F#7		53 Maple Leaf Rag
	G7		54 L'arabesque [25 Etudes Op.100]
C8	A#7		55 La Styrienne [25 Etudes Op.100]
	A7		56 Ave Maria [25 Etudes Op.100]
	B#7		57 Le retour [25 Etudes Op.100]
	B7		58 La chevaleresque [25 Etudes Op.100]
			59 No.13 [Etudes de Mécanisme Op.849]
			60 No.26 [Etudes de Mécanisme Op.849]



## Change tone and other settings

Hold down the “GRAND PIANO” button and select key.

		Note name	Assigned Function		
A0		A0	Upper1 settings	Upper1 Volume	(-)
		B0			(+)
		C1		Upper1 Octave Shift	(-)
C1		C#1	Transpose		(-)
		D1			(+)
		E♭1	Touch Response	Off	
		E1		Light	
		F1		Medium light	
		F#1		Normal	
		G1		Medium heavy	
		A♭1		Heavy	
		A1			
		B♭1			
	B1				
	C2				
C2		C#2			
		D2			
		E♭2			
		E2			
		F2			
		F#2			
		G2			
		A♭2			
		A2			
		B♭2			
C3		B2	Tone Selection		(-)
		C3			(+)
		C#3			
		D3			
		E♭3			
		E3			
		F3			
		F#3			
		G3			
		A♭3		GRAND PIANO CONCERT	
C4		A3		GRAND PIANO BRIGHT	
		A#3		GRAND PIANO MELLOW	
		B♭3		ROCK PIANO	
		B3		JAZZ PIANO	
		C4		BALLAD PIANO	
		C#4		ELEC. PIANO	
		D4		60'S E. PIANO	
		E♭4		DIGITAL E. PIANO 1	
		E4		DIGITAL E. PIANO 2	
		F4		HARPSICHORD	
	F#4		VIBRAPHONE		
	G4		STRINGS 1		
	A♭4		STRINGS 2		
	A4		PIPE ORGAN		
	B♭4		JAZZ ORGAN		
	B4		ELEC ORGAN 1		
	C5		ELEC ORGAN 2		
C5		C#5		BASS (LOWER)	
		D5			
		E♭5			
		E5			
		F5			
		F#5			
		G5			
		A♭5			
		A5			
		B♭5			
	B5				
C6		C6			
		C#6			
		D6			
		E♭6			
		E6			
		F6			
		F#6			
		G6			
		A♭6			
		A6			
	B♭6				
	B6				
C7		C7	Layer settings	Layer	Off/On
		C#7		Upper2 Volume	(-)
		D7			(+)
		E♭7		Upper2 Octave Shift	(-)
		E7			(+)
		F7	Split settings	Upper2 Detune	(-)
		F#7			(+)
		G7		Upper2 Damper	disable/enable
		A♭7		Lower Volume	(-)
		A7			(+)
	B♭7	Lower Detune	(-)		
	B7		(+)		
	C8	Lower Damper	disable/enable		

# MIDI Implementation Chart

Model: AP-300/AP-S200

Version : 1.0

Function		Transmitted	Recognized	Remarks
<b>Basic Channel</b>	Default	1	1 - 16	
	Changed	1 - 16	1 - 16	
<b>Mode</b>	Default	Mode 3	Mode 3	
	Messages Altered	X * * * * *	X * * * * *	
<b>Note Number</b>		0 - 127	0 - 127	
	True voice	* * * * *	0 - 127*1	
<b>Velocity</b>	Note ON	0 9nH v = 1 - 127	0 9nH v = 1 - 127	
	Note OFF	X 8nH v = 64	0 9nH v = 0, 8nH v = 0 - 127	
<b>After Touch</b>	Key's	X	X	
	Ch's	X	O	
<b>Pitch Bender</b>		X	O	
<b>Control Change</b>	0, 32	O	O	Bank select LSB/MSB
	1	X	X	Modulation
	5	X	X	Portamento time
	6, 98	X *2	O *2	Data entry LSB/MSB
	7	O	O	Channel Volume
	10	X	O	Pan
	11	X	O	Expression
	64	O	O	Damper Pedal (Sustain)
	65	X	O	Portamento On/Off
	66	O	O	Sostenuto
	67	O	O	Soft pedal
	71	X	O	Filter resonance
	72	X	O	Release time
	73	X	O	Attack time
	74	X	O	Filter Cutoff Frequency
	76	X	O	Vibrato rate
	77	X	O	Vibrato depth
	78	X	O	Vibrato delay
	84	O *3	O	Portamento control
	88	X	O	High resolution velocity prefix
91	X	O	Reverb send level	
93	X	O	Chorus send level	
94	X	O	Delay send level	
100, 101	O *2	O *2	RPN LSB/MSB	
<b>Program Change</b>	True #	O * * * * *	O 0 - 127	
<b>Exclusive</b>		O *2	O *2	
<b>System Common</b>	Song Pos	X	X	
	Song Sel	X	X	
	Tune	X	X	
<b>System Real Time</b>	Clock	X	X	
	Commands	X	X	
<b>Aux Messages</b>	All sound off	X	O	
	Reset all controller	X	O	
	Local ON/OFF	X	X	
	All notes OFF	X	O	
	Active Sense	X	O	
	System Reset	X	X	
<b>Remarks</b>		<p>*1: Depends on tone.</p> <p>*2: For details about RPN and system exclusive messages, see MIDI Implementation at <a href="https://support.casio.com/global/en/emi/manual/AP-300/">https://support.casio.com/global/en/emi/manual/AP-300/</a>  <a href="https://support.casio.com/global/en/emi/manual/AP-S200/">https://support.casio.com/global/en/emi/manual/AP-S200/</a></p> <p>*3: Note ON only</p> <ul style="list-style-type: none"> <li>The MIDI messages marked with "x" in the "Transmitted" column of the above chart may be output along with certain operations.</li> </ul>		

Mode 1 : OMNI ON, POLY  
 Mode 3 : OMNI OFF, POLY

Mode 2 : OMNI ON, MONO  
 Mode 4 : OMNI OFF, MONO

O : Yes  
 X : No

**CASIO®**